

| | | | | |
|------------------------------|-----------------------------|--------------------------------|-------------------------------|----------------------------|
| BG ПОКРИВНИ ПРОЗОРЦИ | FR FENÊTRES DE TOIT | IT FINESTRE PER TETTI | RO GEAMURI DE ACOPERIŞ | TR çatı pencereleri |
| CZ STŘEŠNÍ OKNA | GB ROOF WINDOWS | MK ПРОЗОРЦИ НА ПОКРИВОТ | RU МАНСАРДНЫЕ ОКНА | |
| DE DACHFENSTER | GR ΠΑΡΑΘΥΡΑ ΟΡΟΦΗΣ | PL OKNA DACHOWE | SE TAKFÖNSTER | |
| ES VENTANA DE TEJADOS | HU TETŐTÉRI ABLAOKOK | PT JANELAS DE SÓTÃO | SK STŘEŠNÉ OKNÁ | |

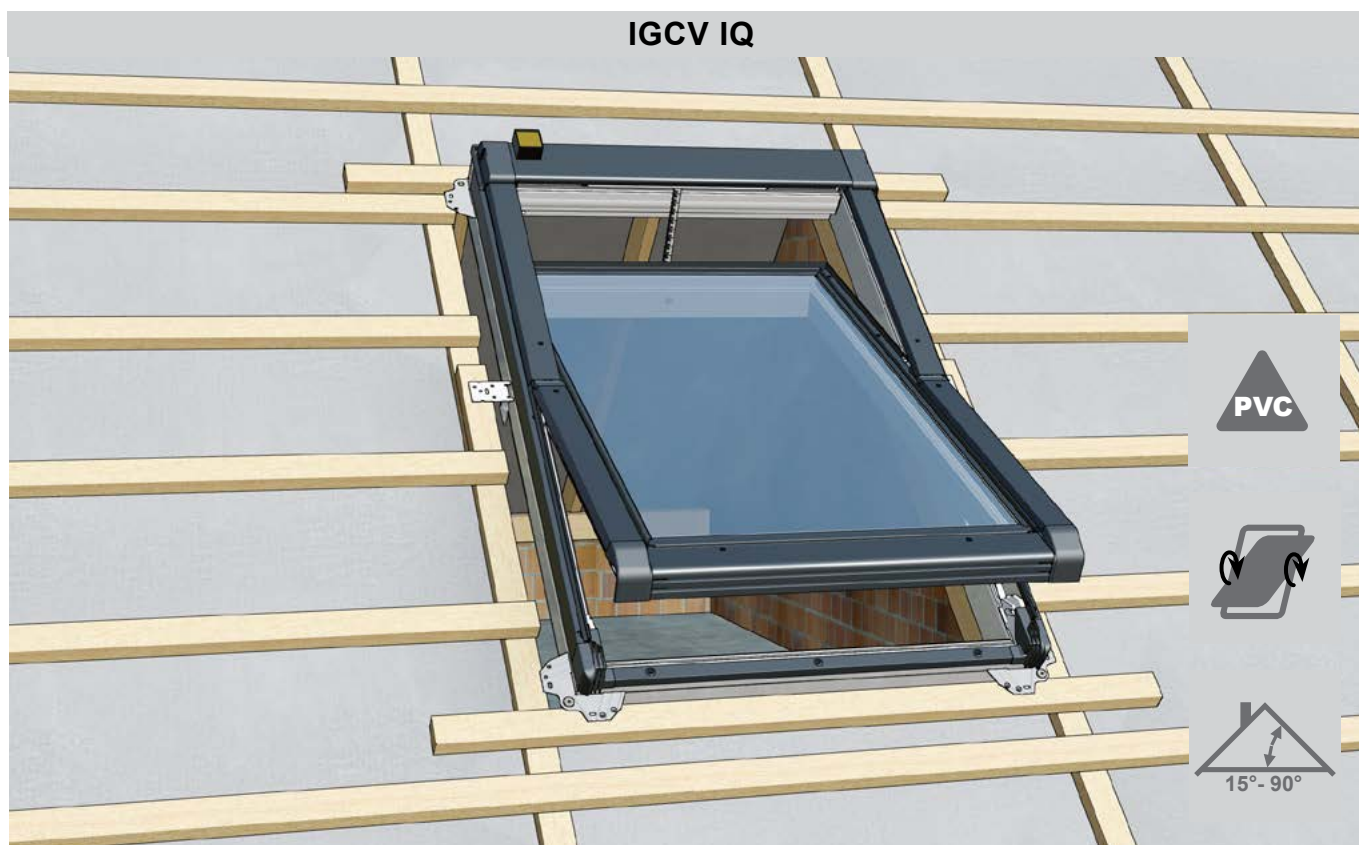







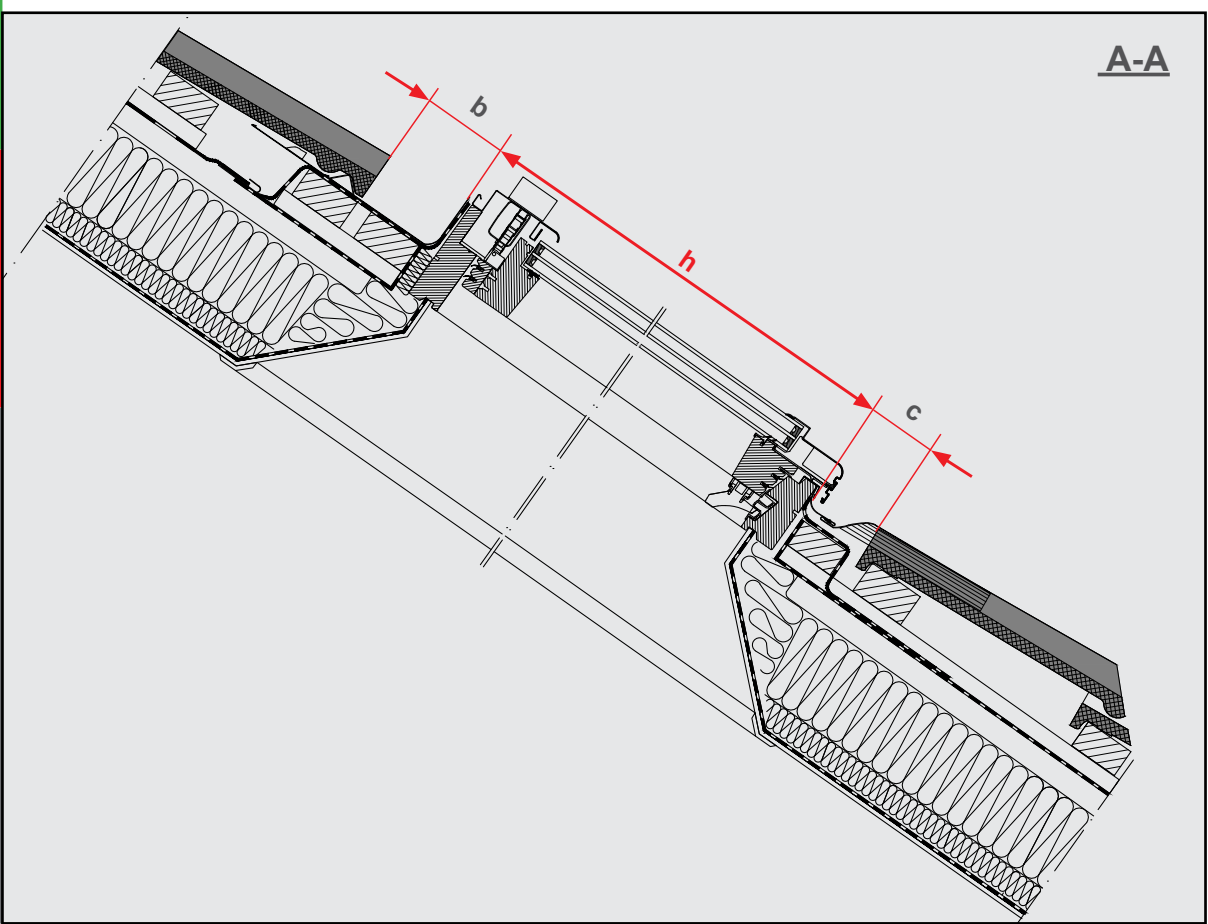
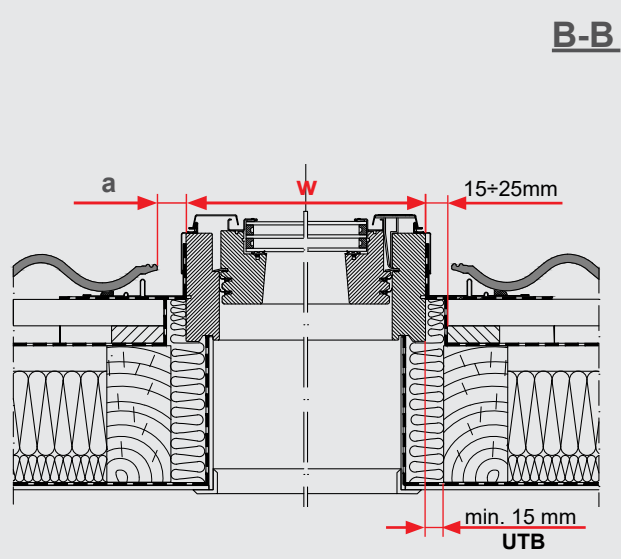
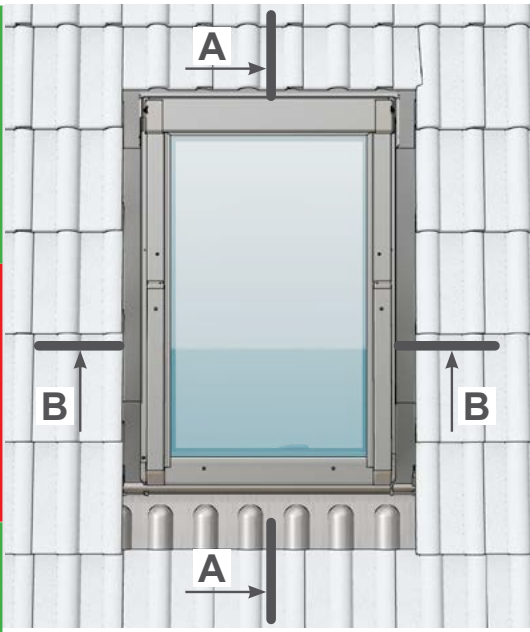
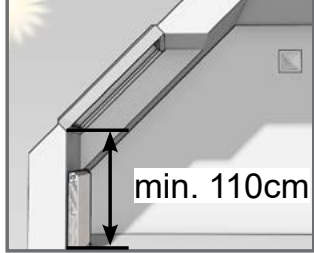
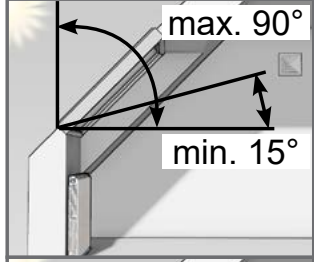
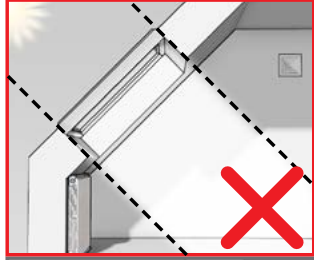
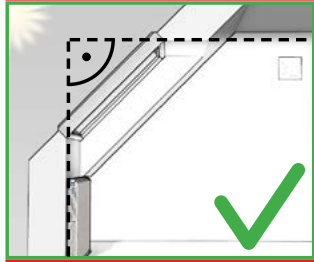
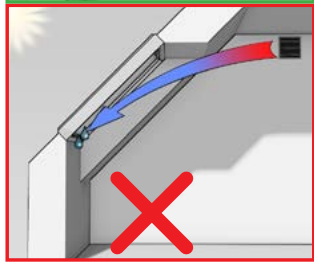
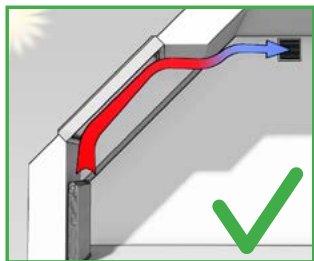

ISC IQ, VSC IQ

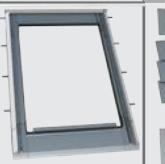
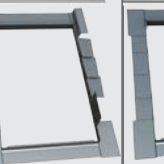
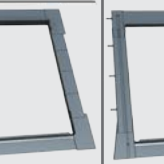

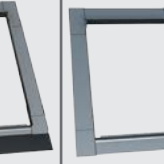
IGCV IQ





| |  |  |  |  |  |  |  |  |  |
|---|--|---|---|---|---|--|---|---|---|
| | H12 [mm] | H9 [mm] | H5 [mm] | D [mm] | LH [mm] | L [mm] | P [mm] | BPH9 [mm] | R [mm] |
|  | min. 30 max. 60 | min. 30 max. 60 |  | min. 45 max. 50 | min. 45 max. 50 | min. 0 max. 20 | min. 45 max. 50 | 0 0 | min. 90 max. 130 |
|  | 60 + 150 | 60 + 150 | 60 + 150 | 60 + 150 | 60 + 150 | 60 + 150 | 60 + 150 | 60 + 10 | max 200 |
|  | 90 + 110 | 90 + 110 | 60 + 70 | 100 + 110 | 20 + 50 | 20 + 50 | 20 + 50 | 60+70 | 50+120 |



ISC IQ VSC IQ

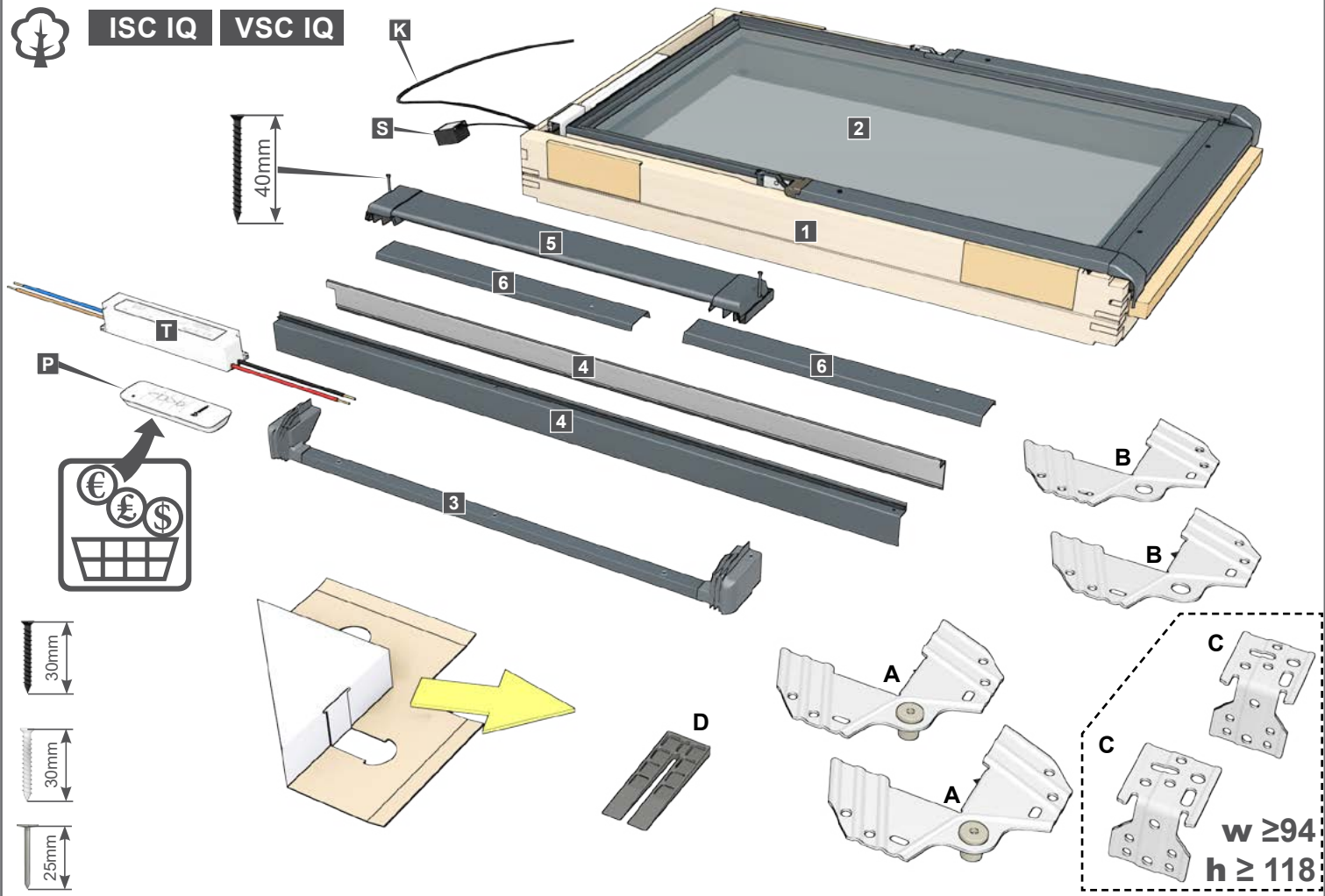

PVC IGCV IQ

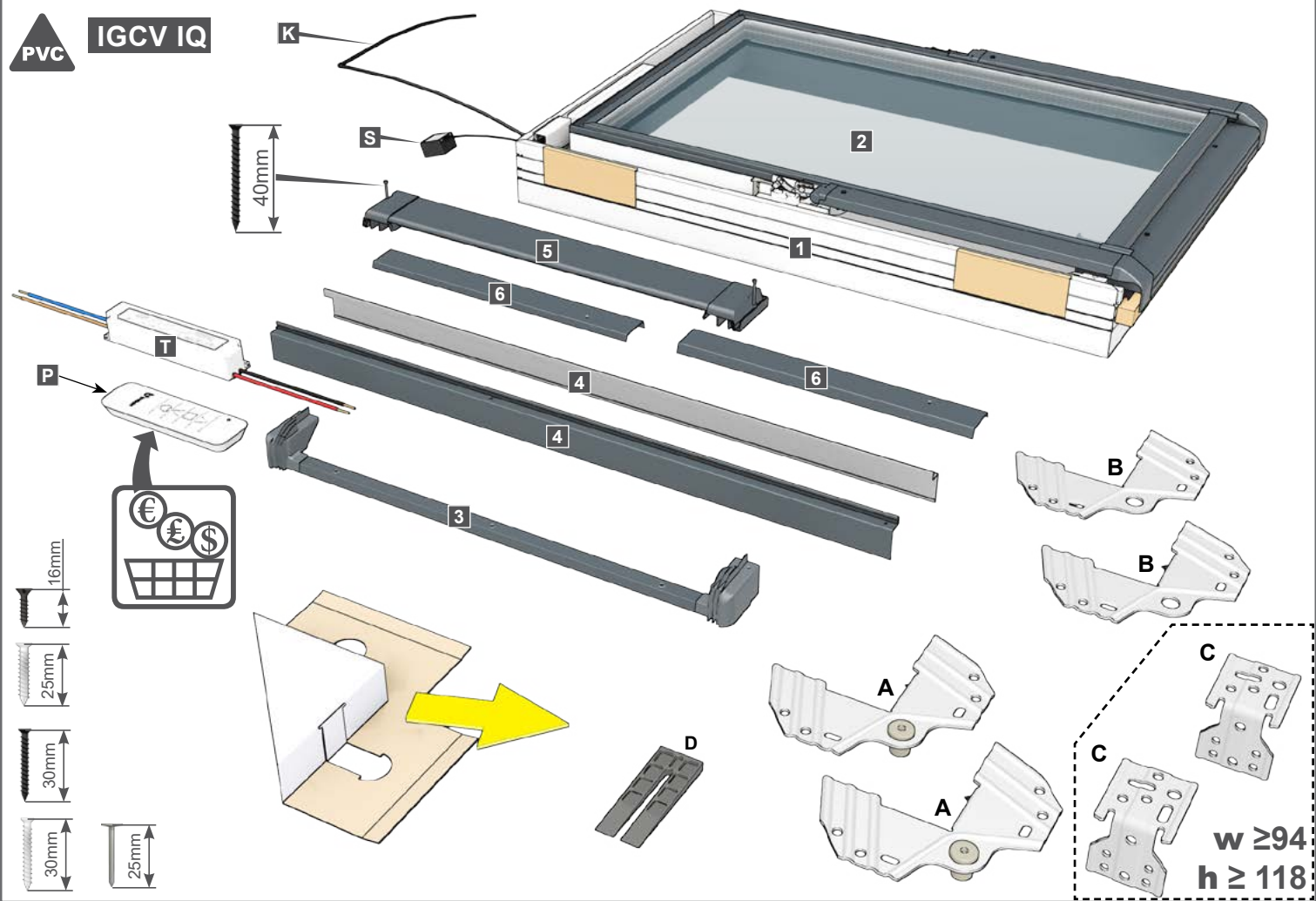

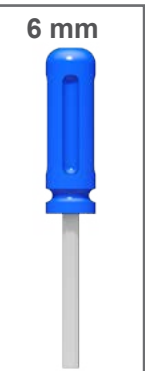
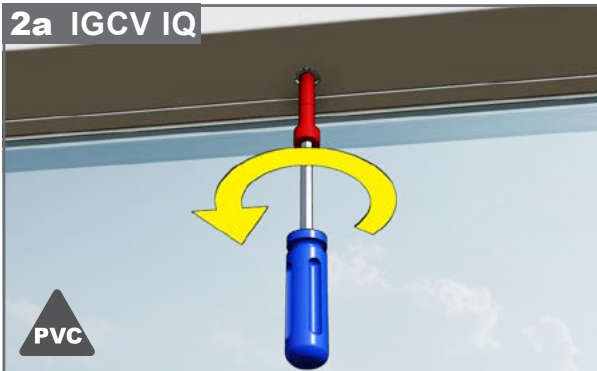
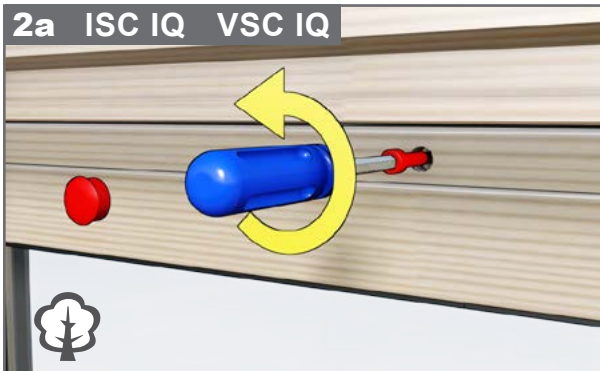
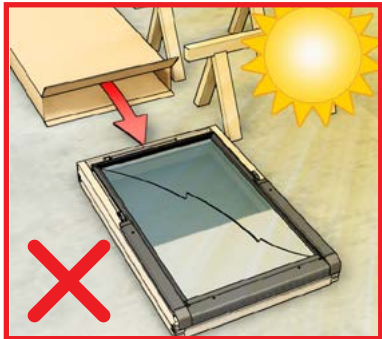
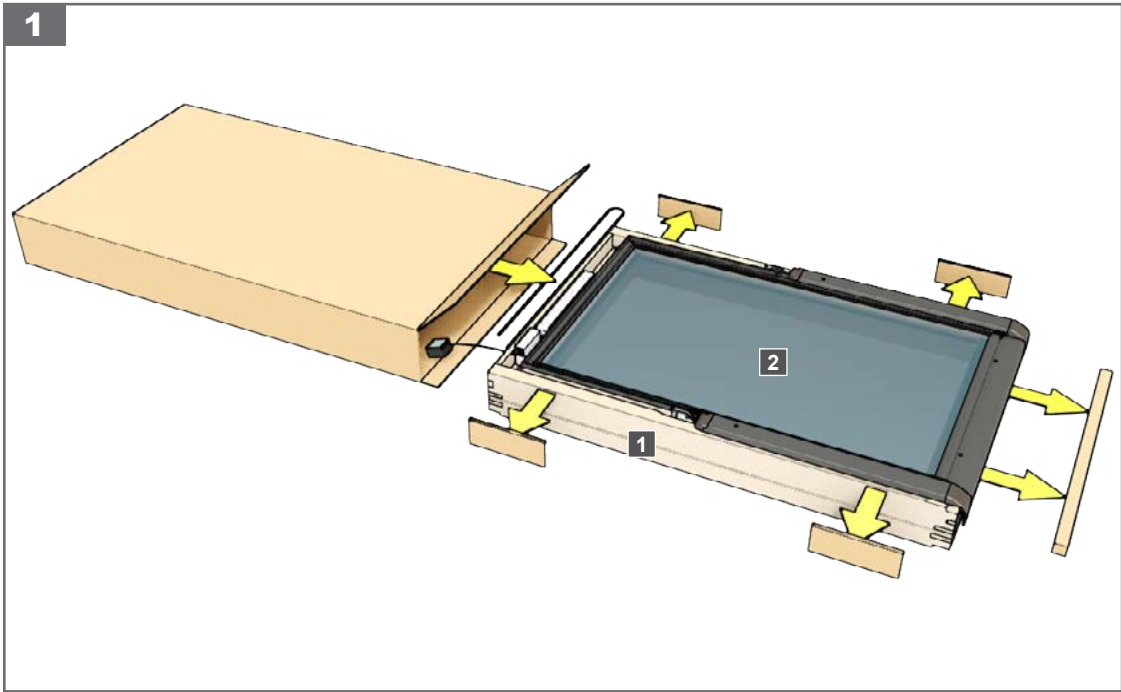

2b

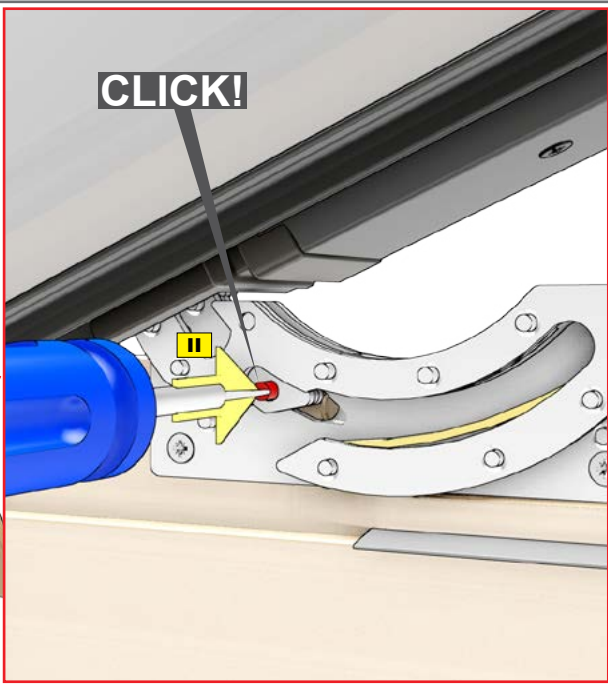
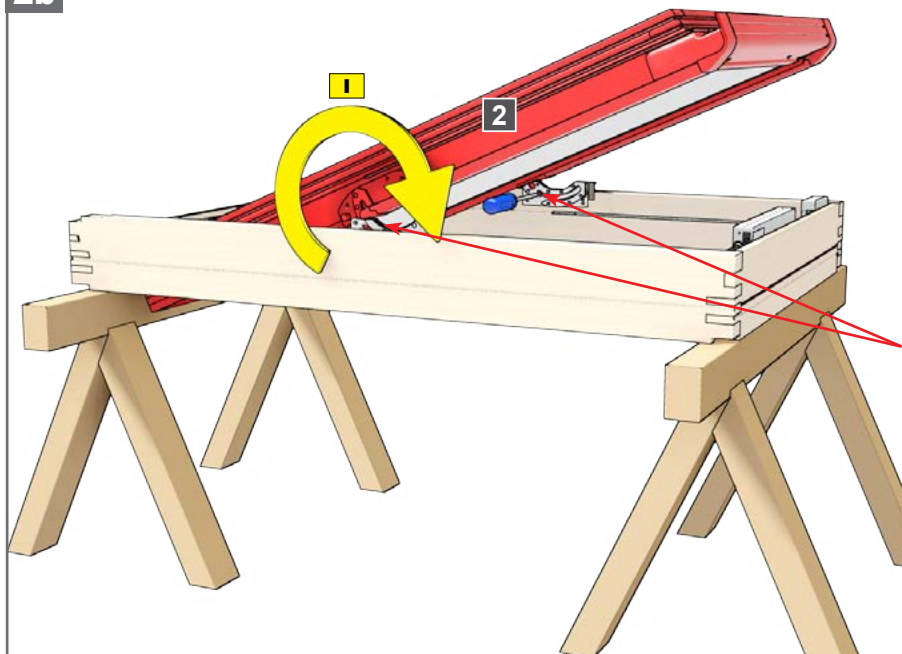

2c

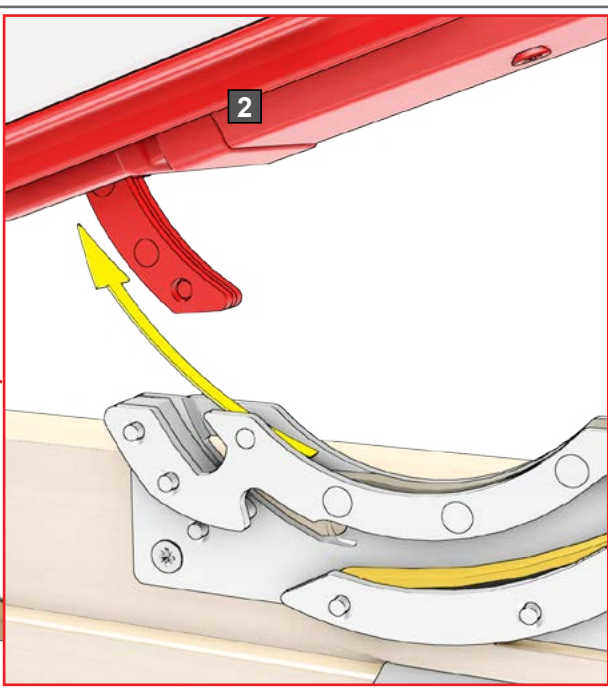
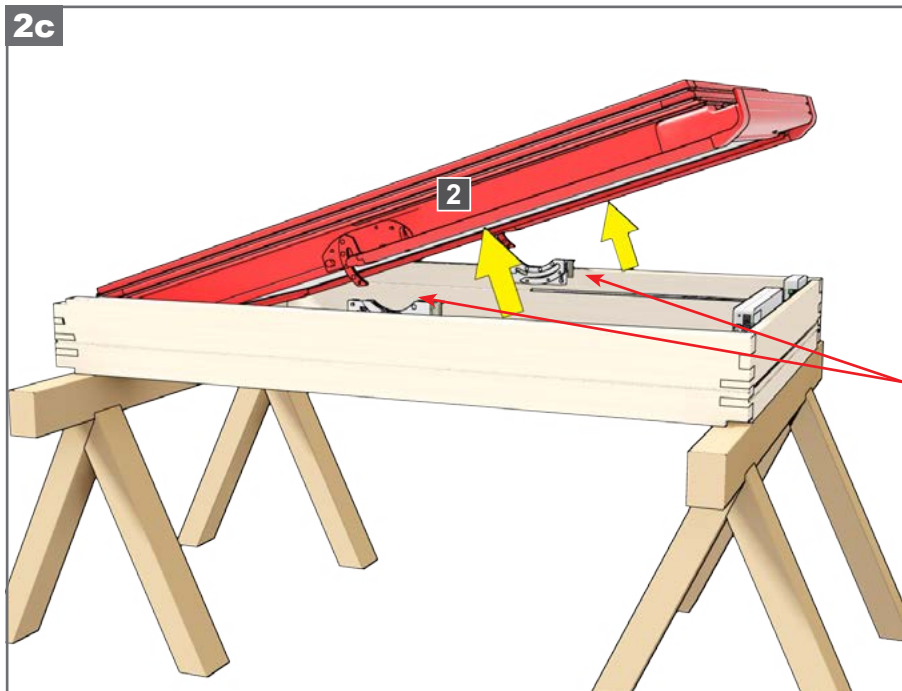

3

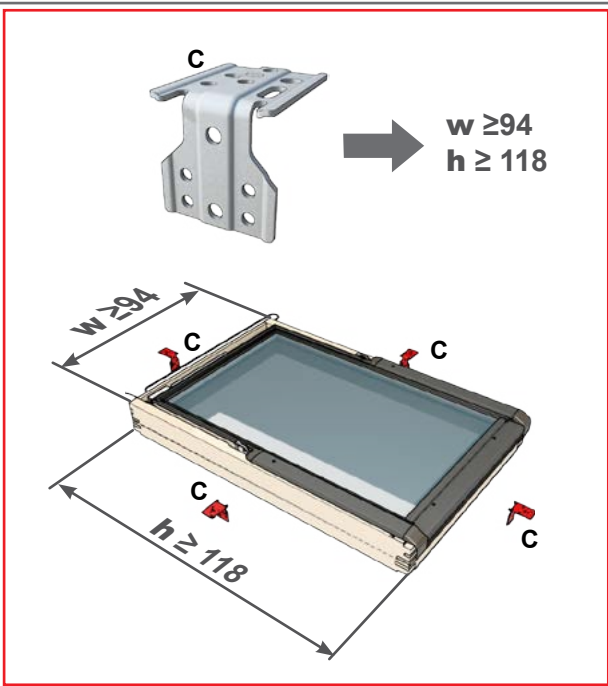
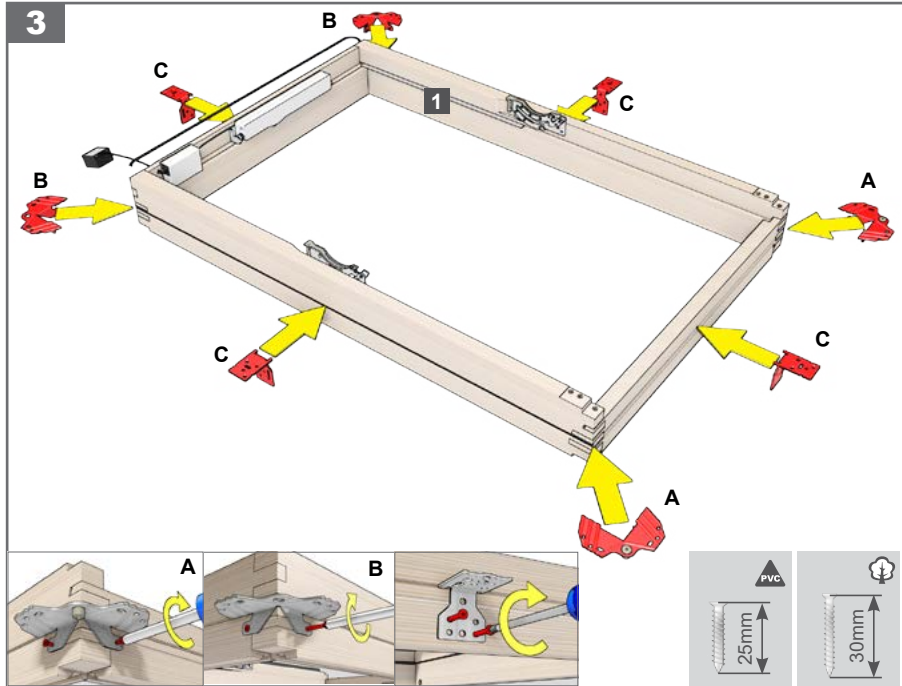

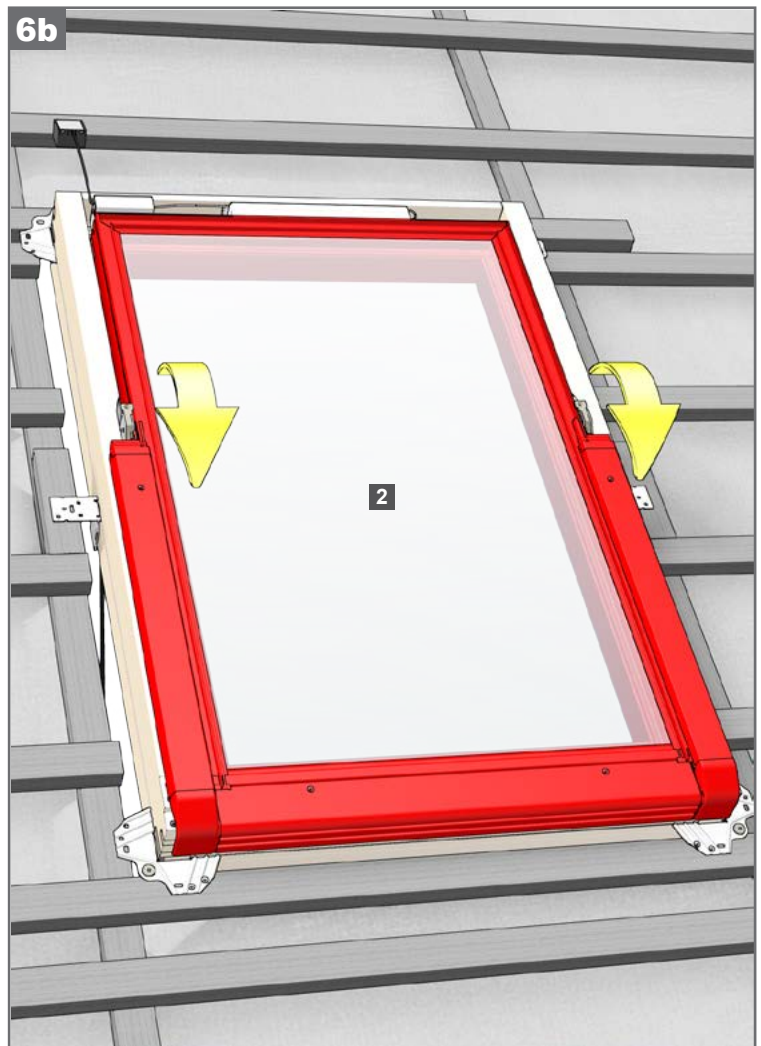
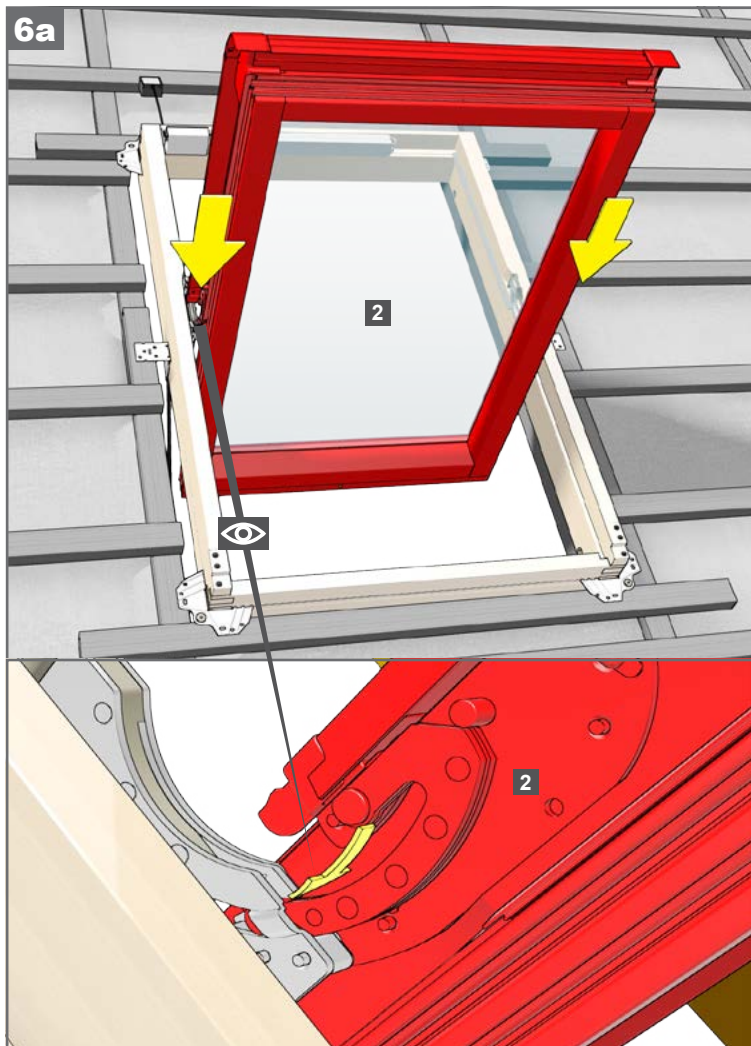
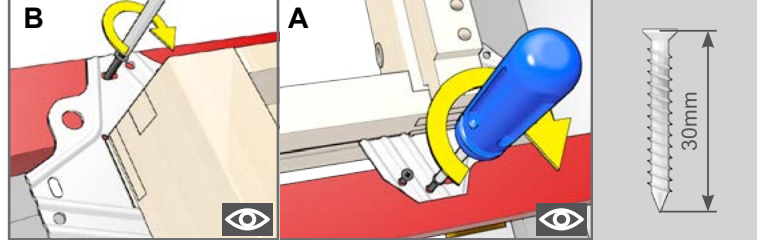
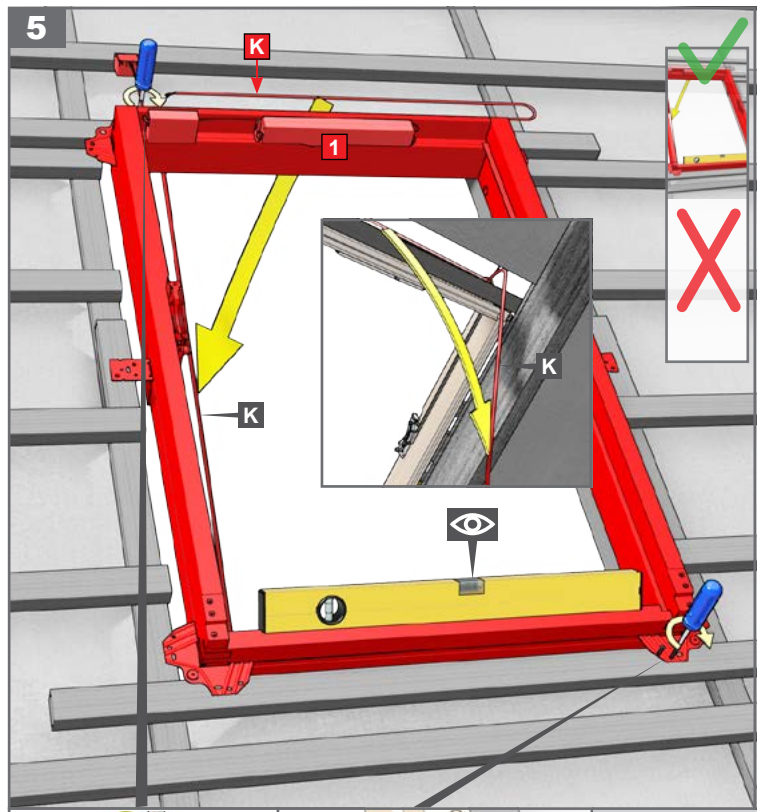
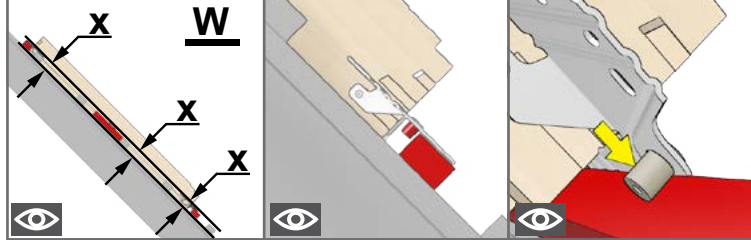
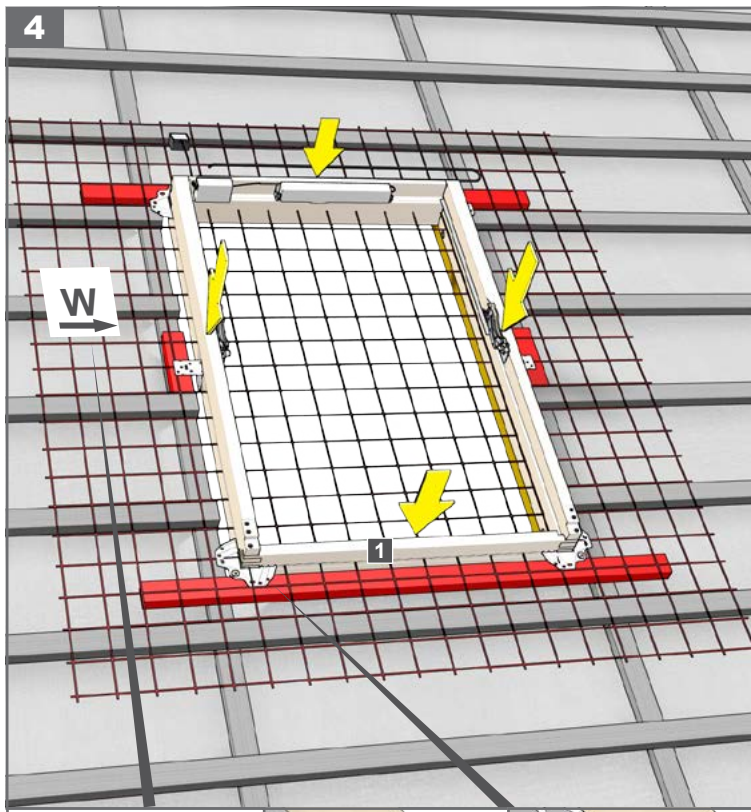

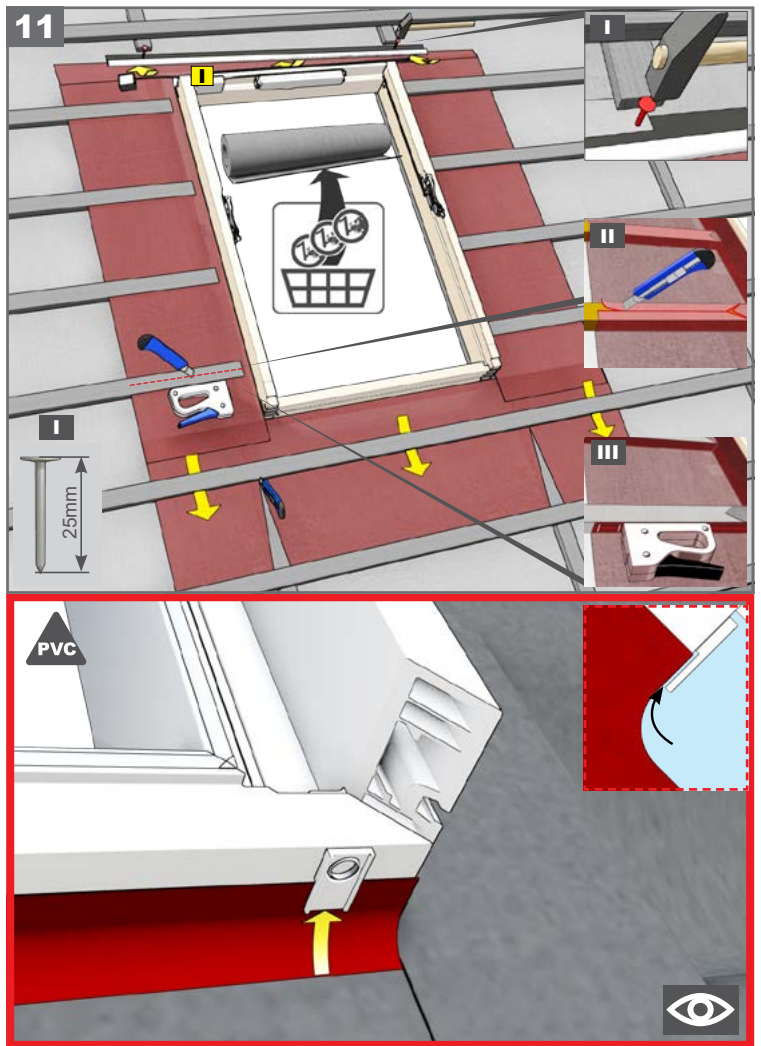
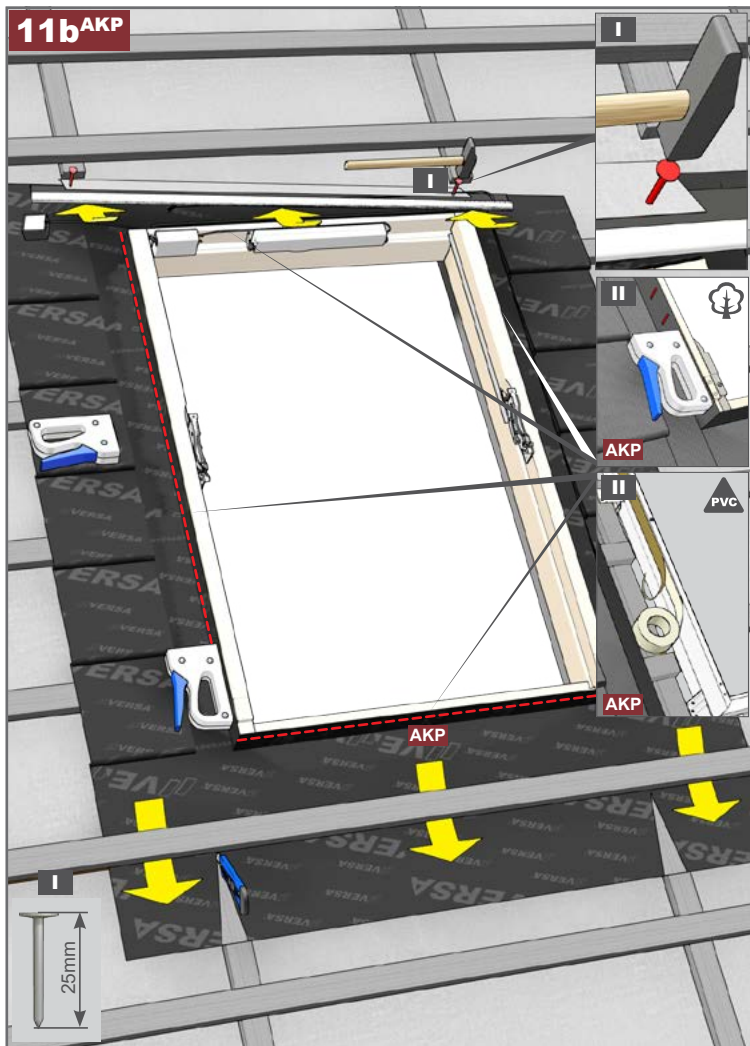
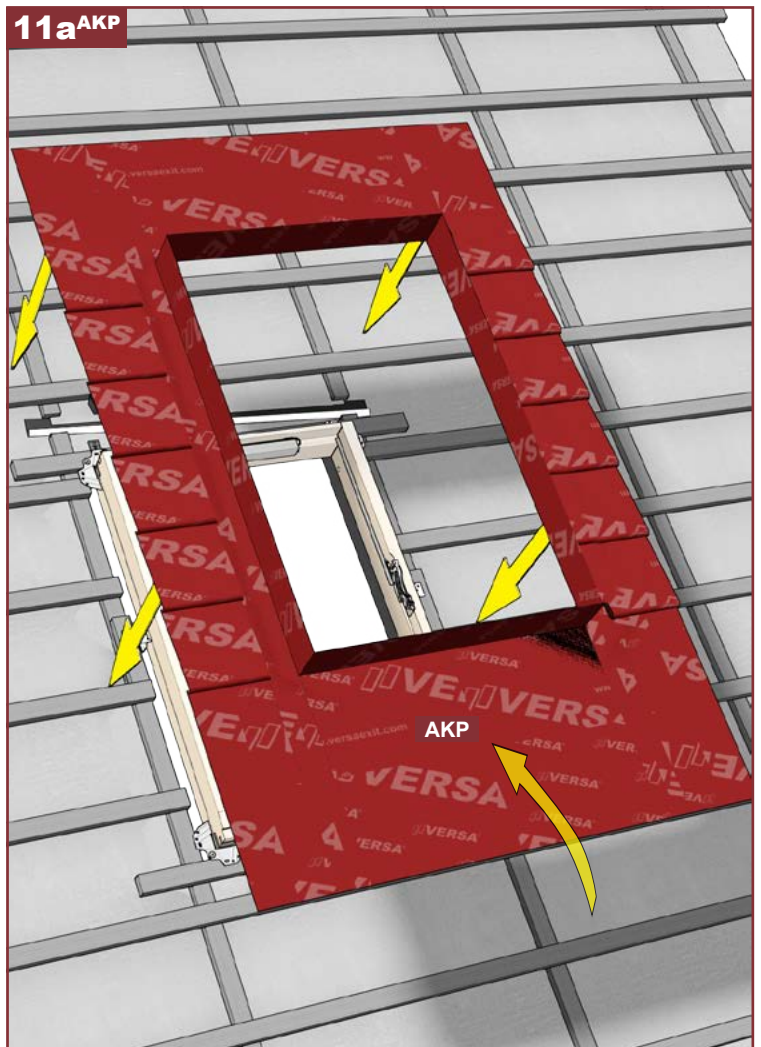
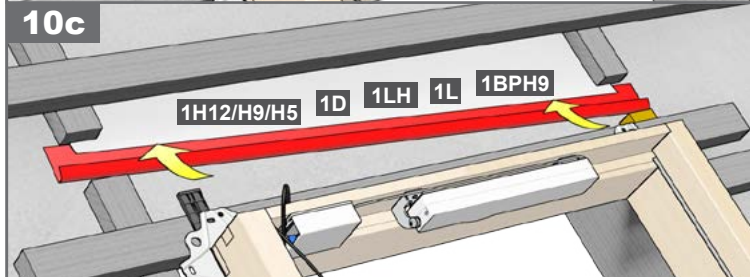
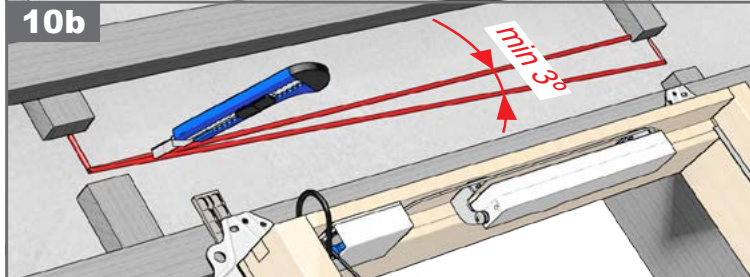
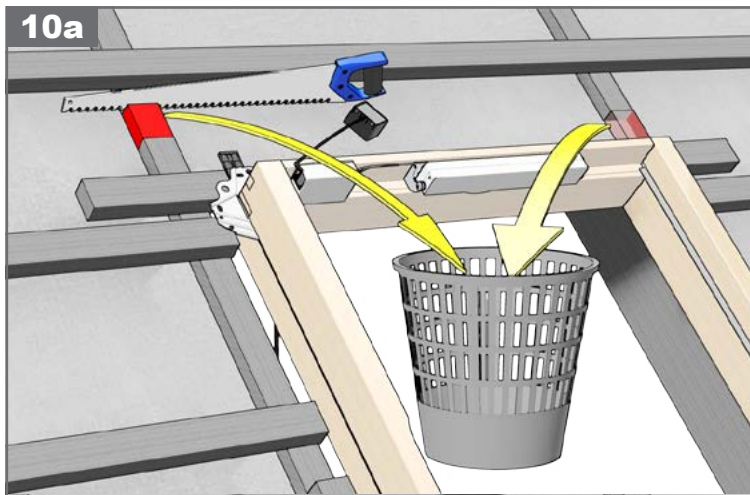

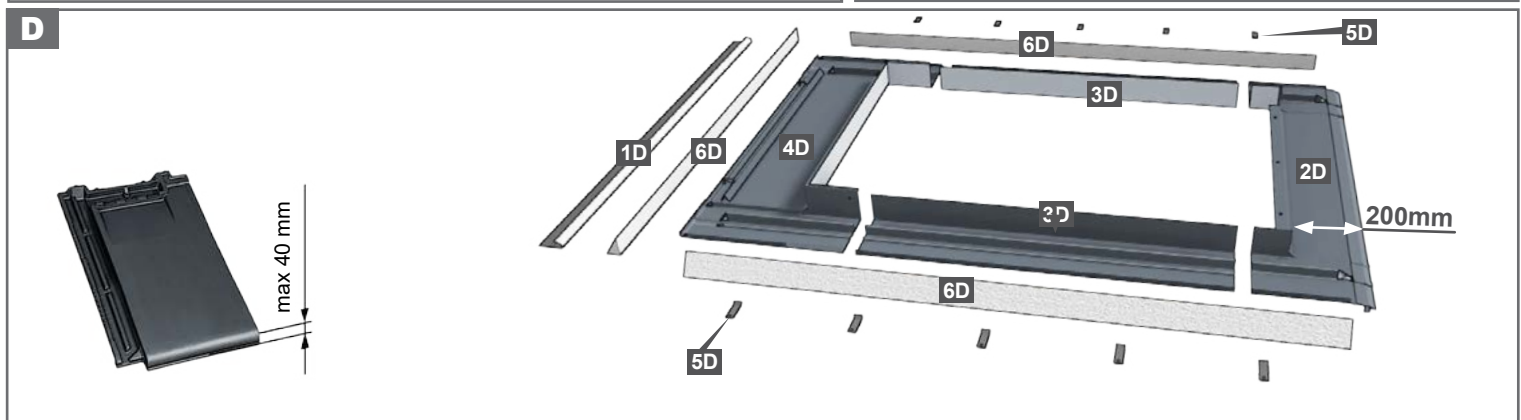
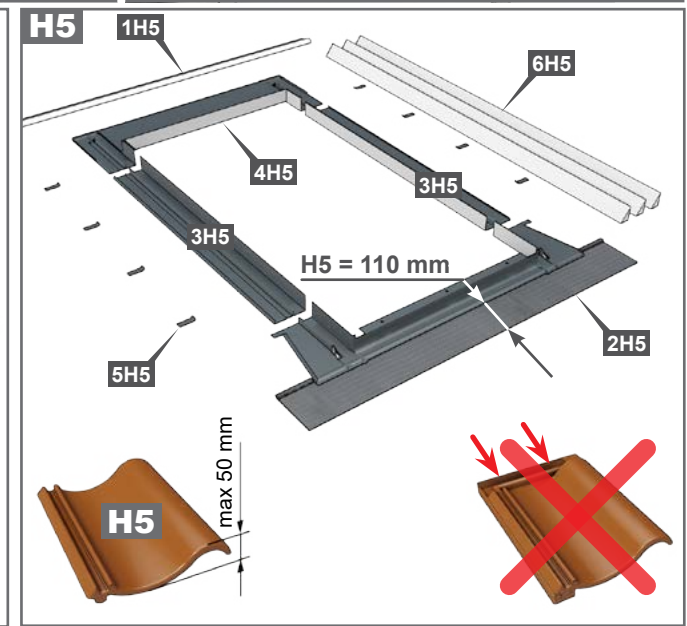
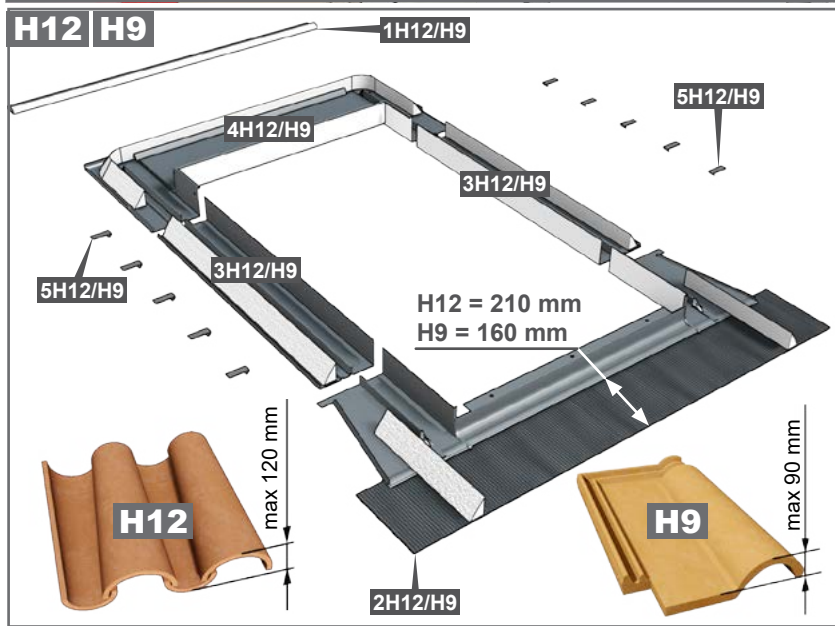
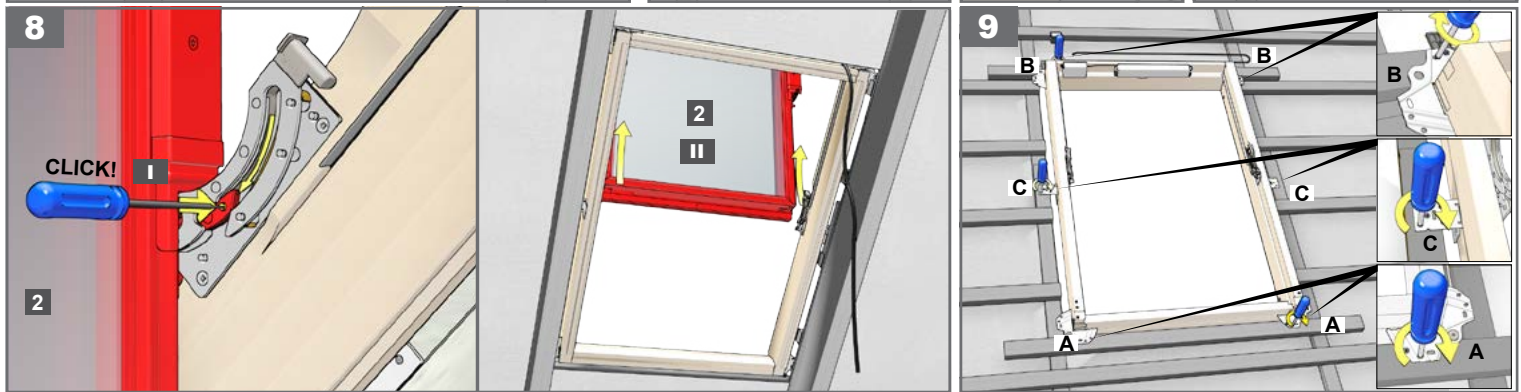
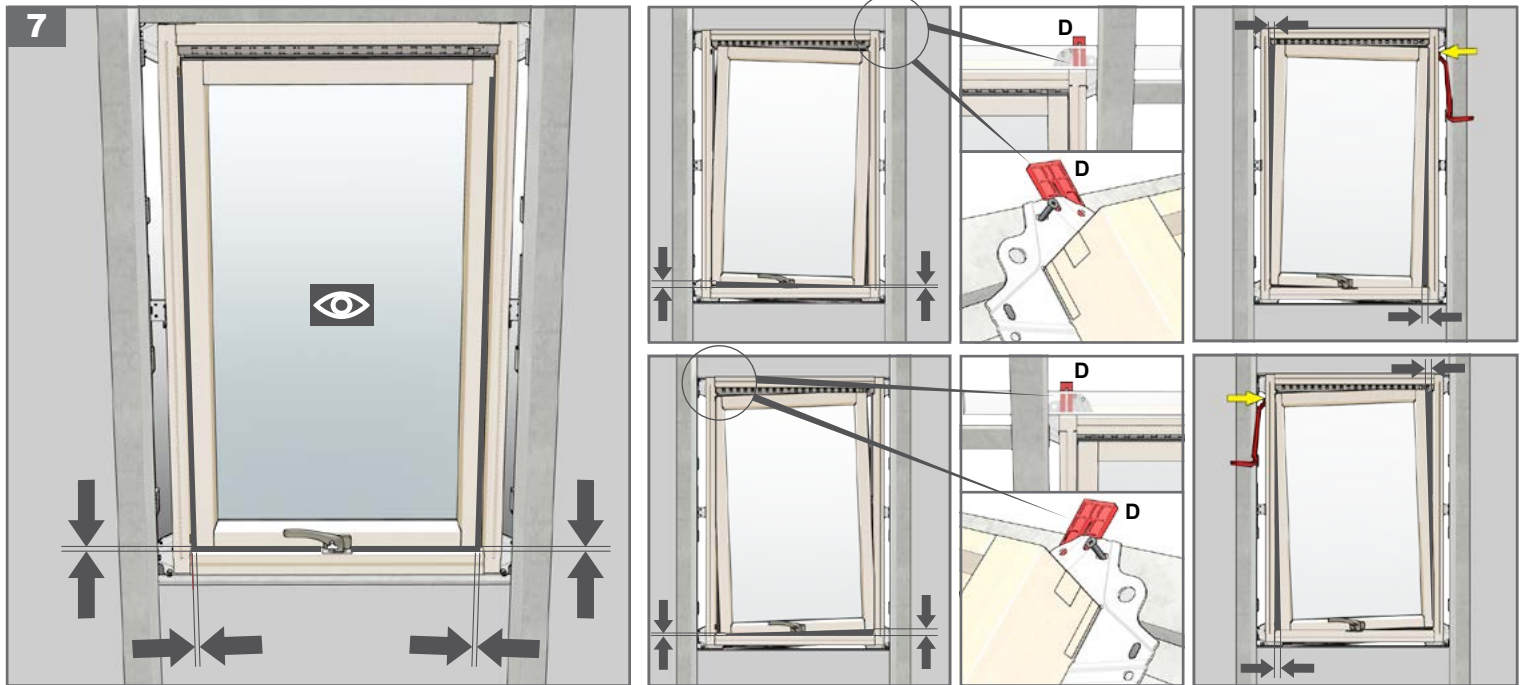

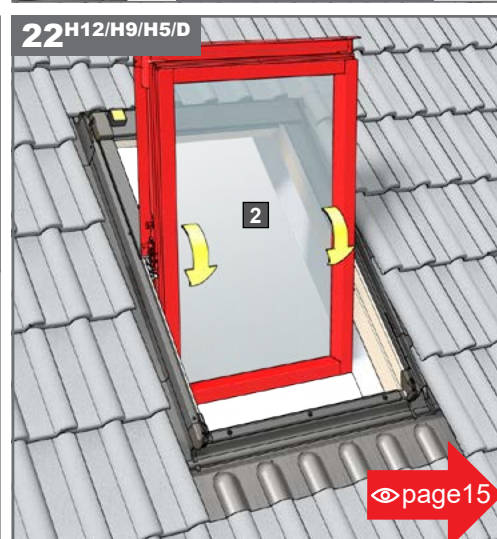
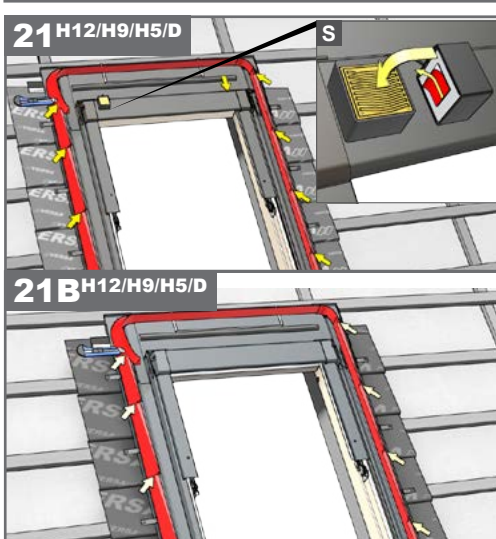
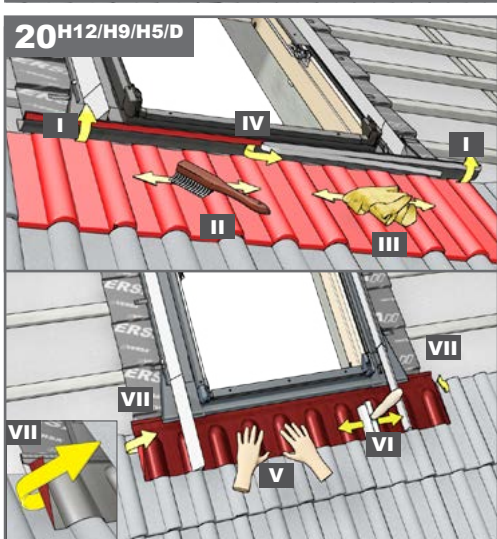
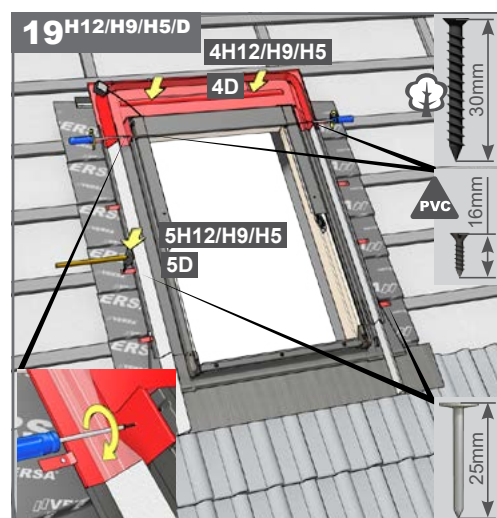
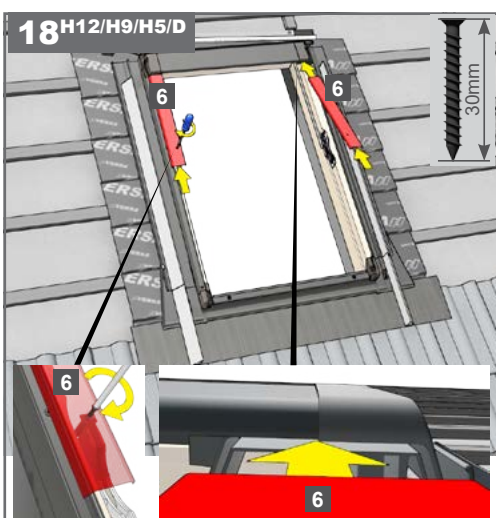
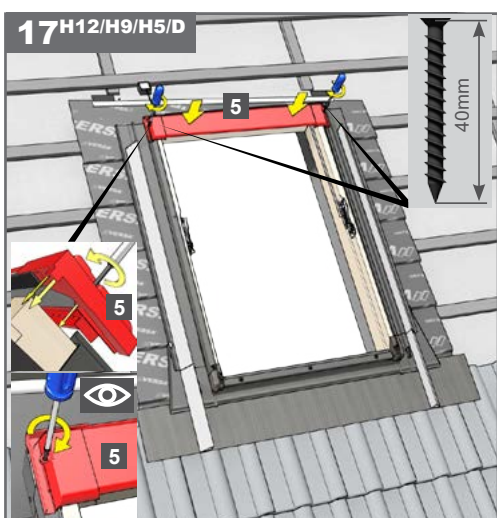
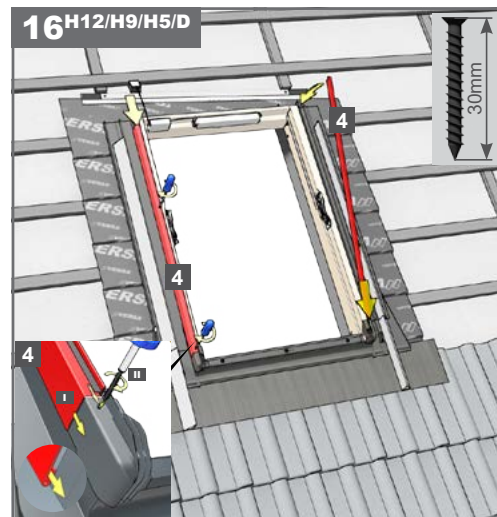
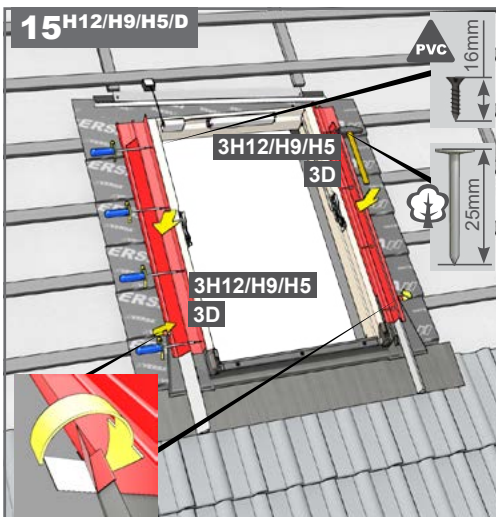
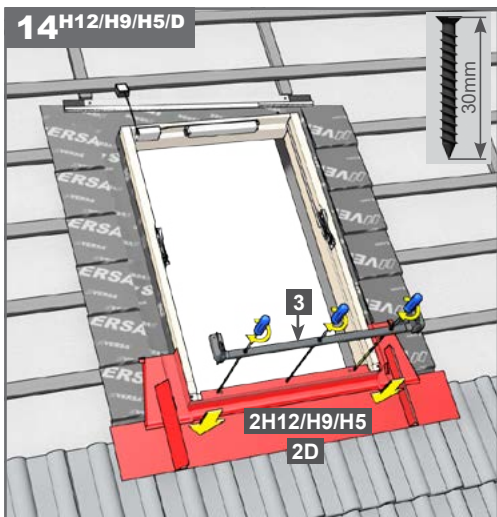
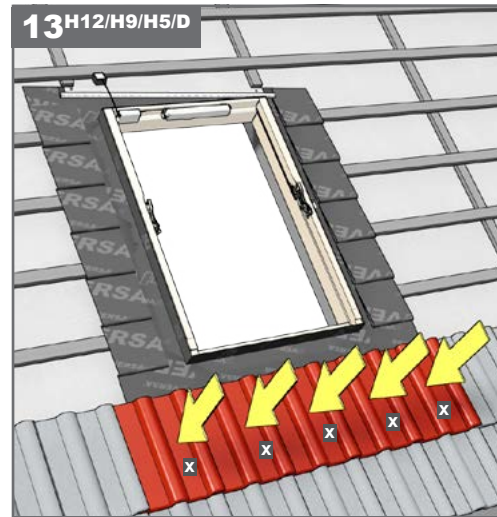
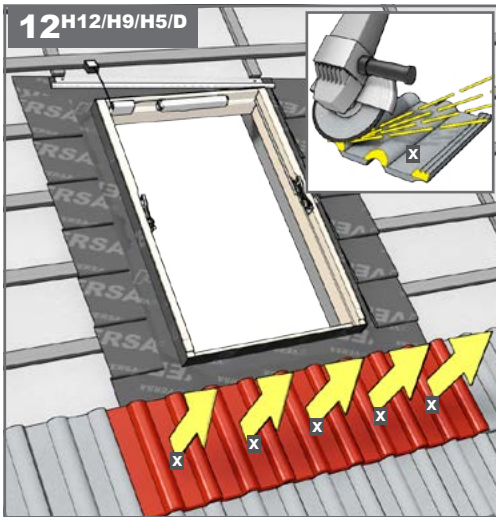
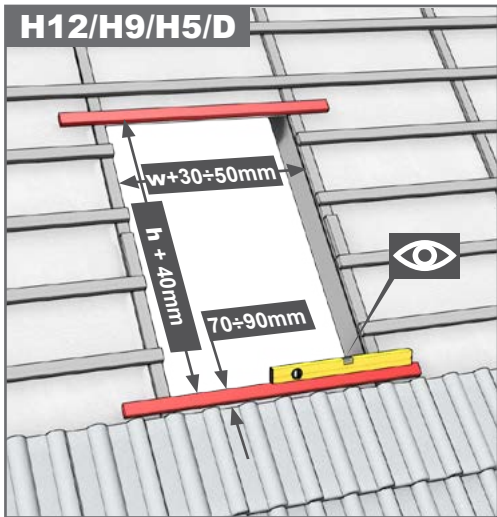

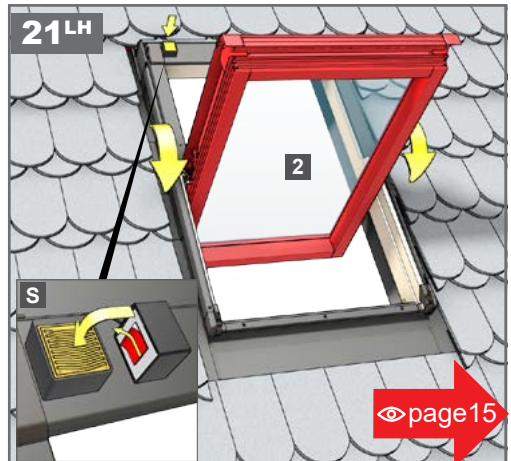
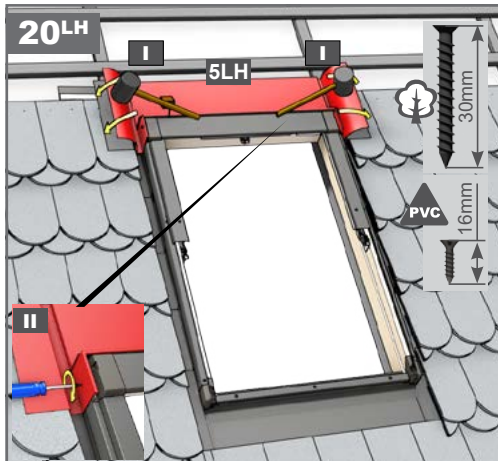
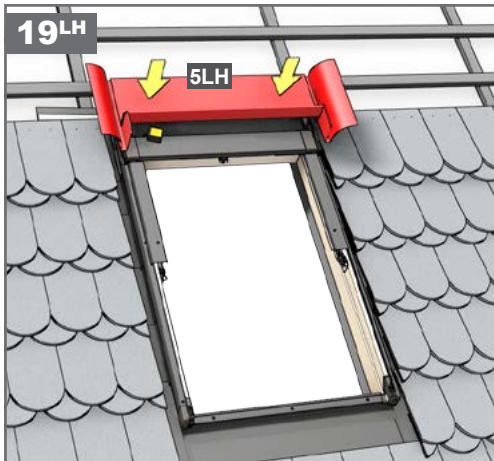
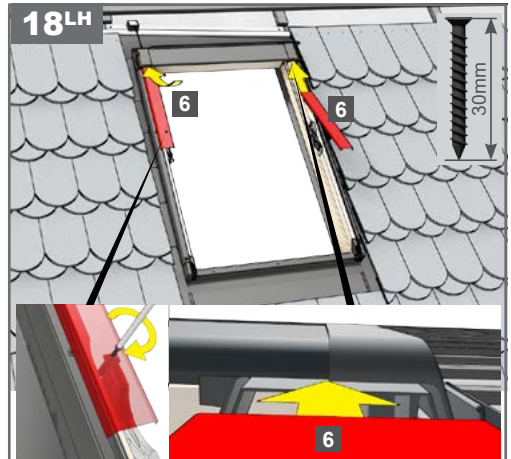
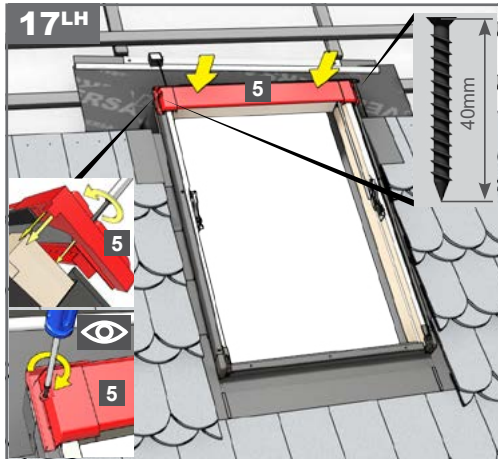
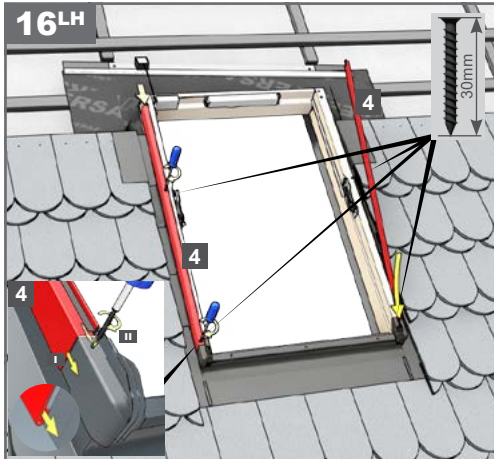
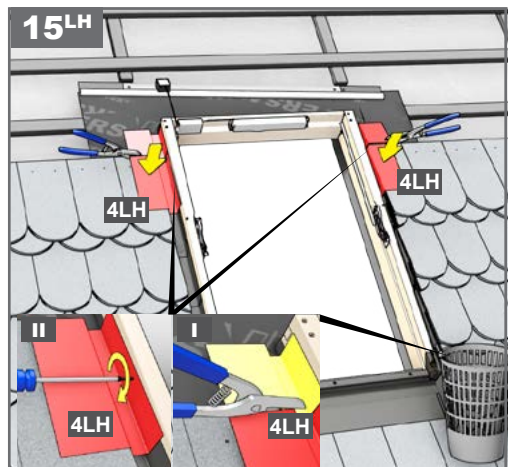
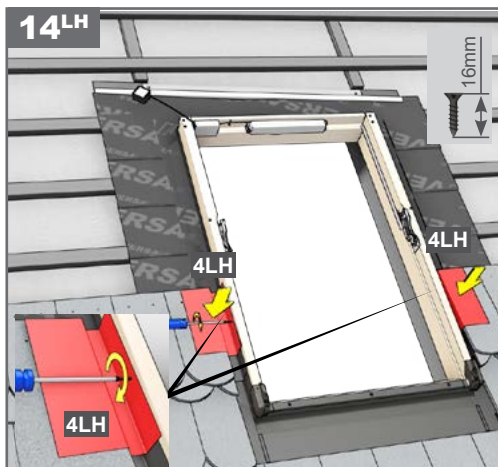
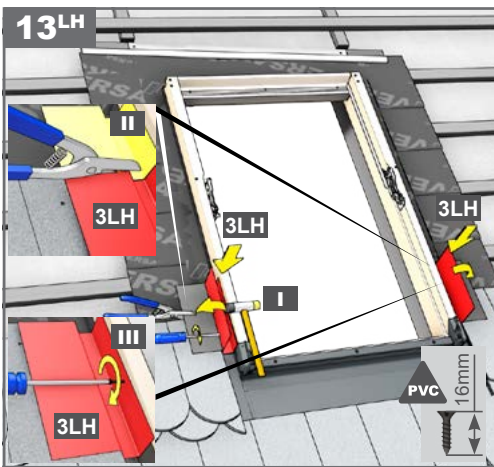
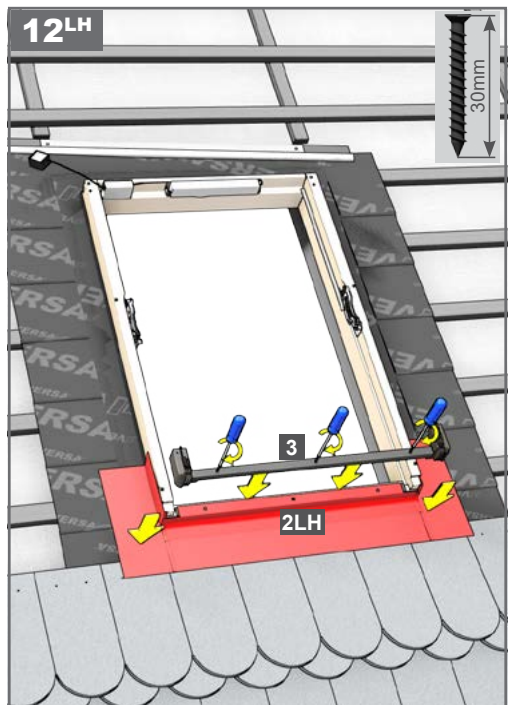
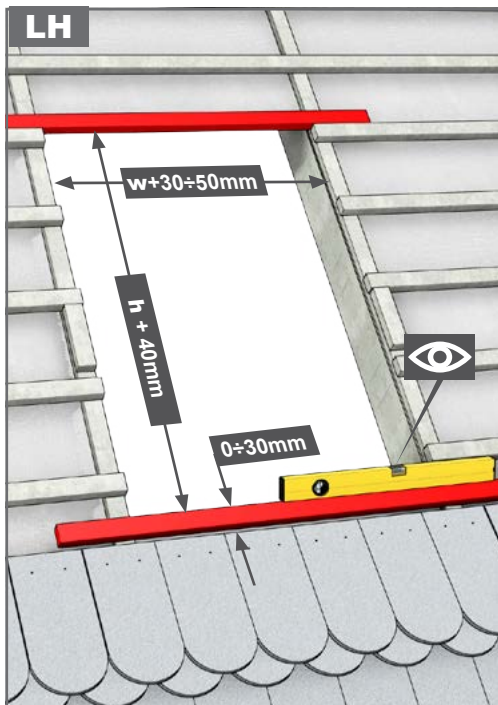
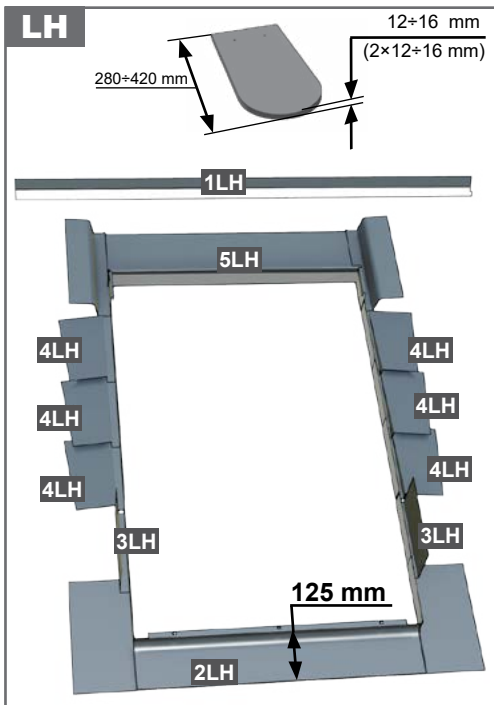

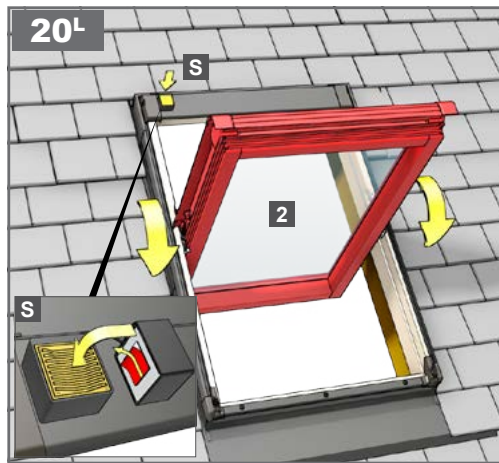
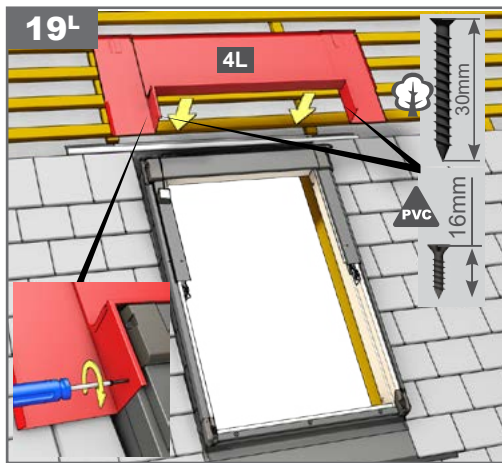
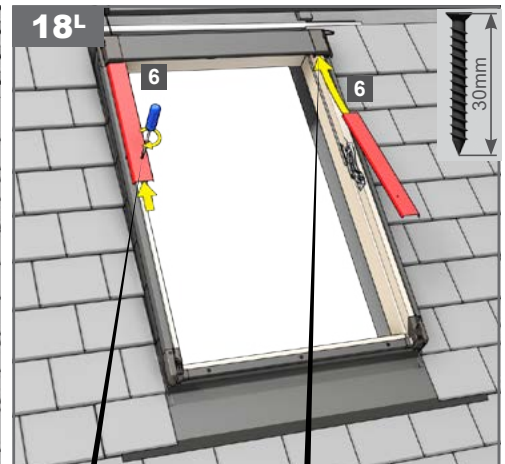
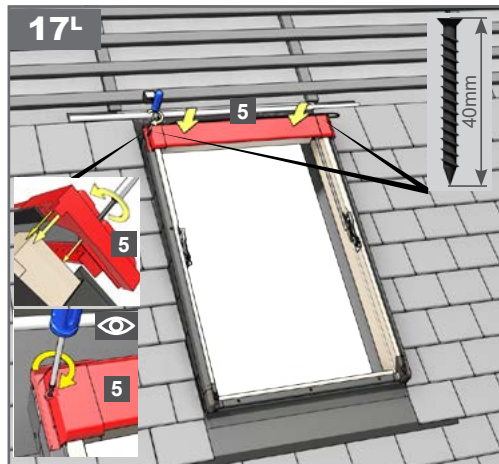
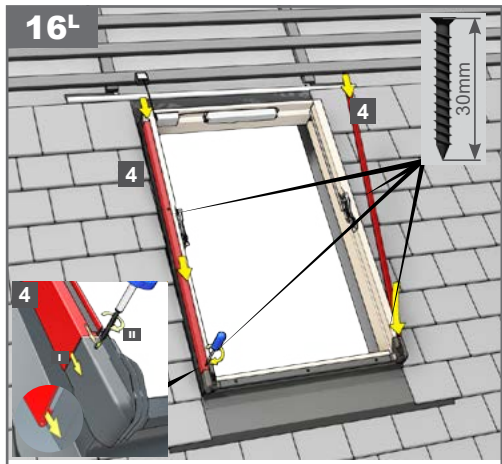
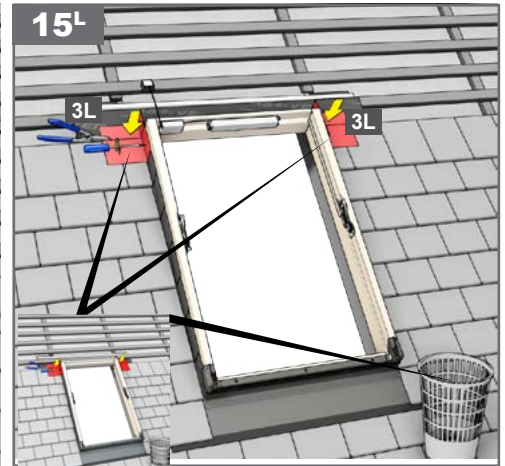
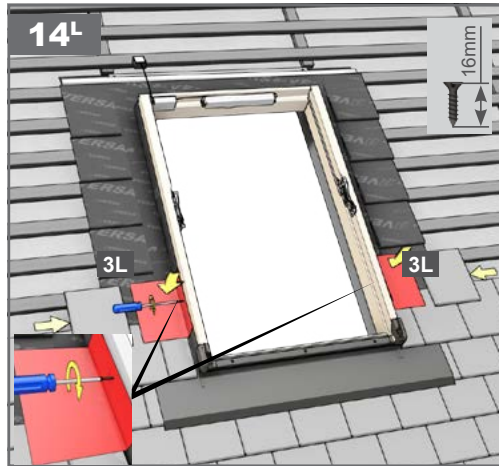
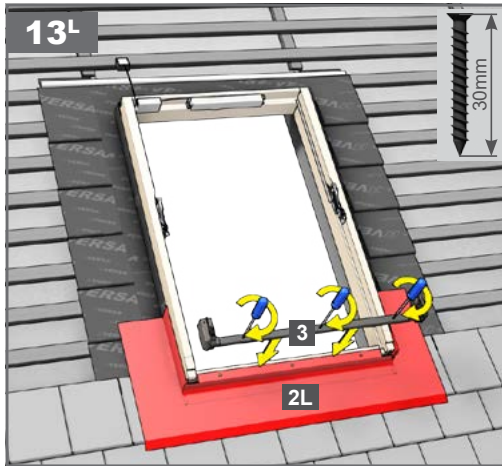
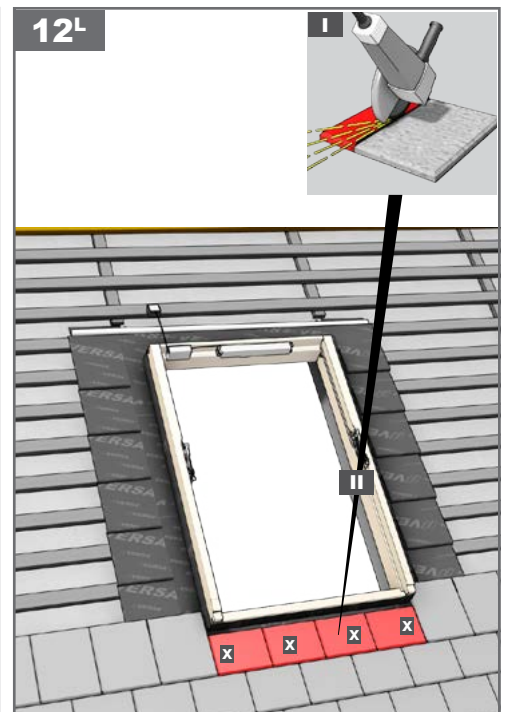
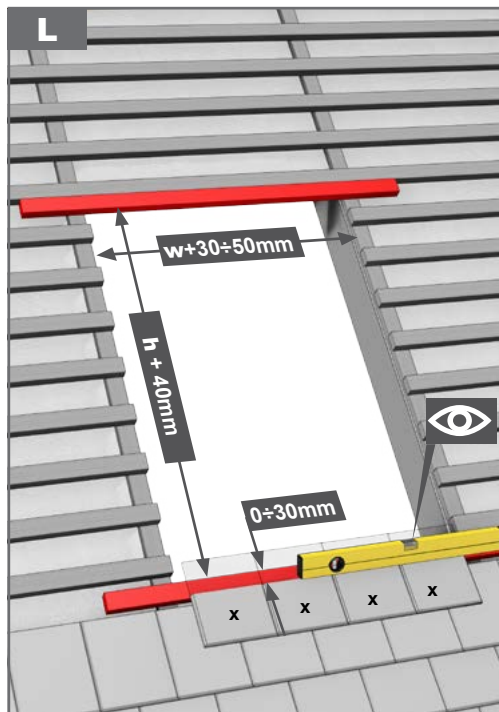
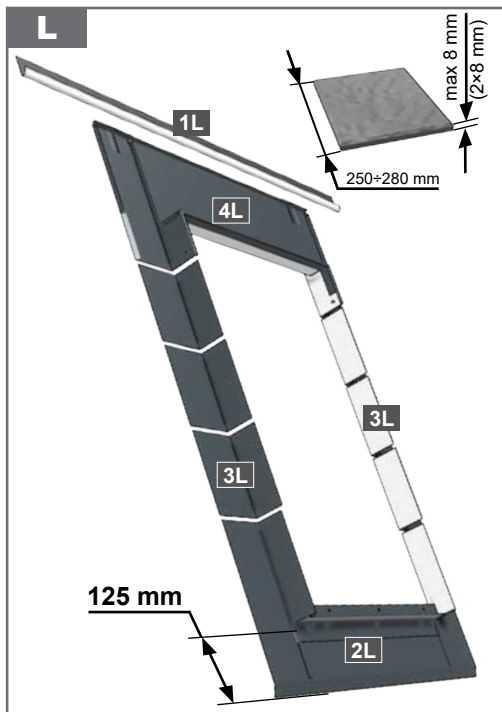

👁️ page 15

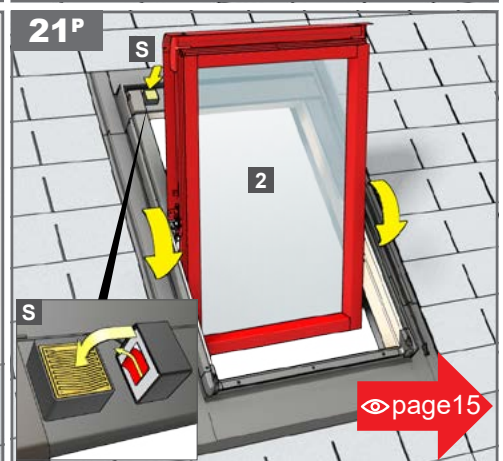
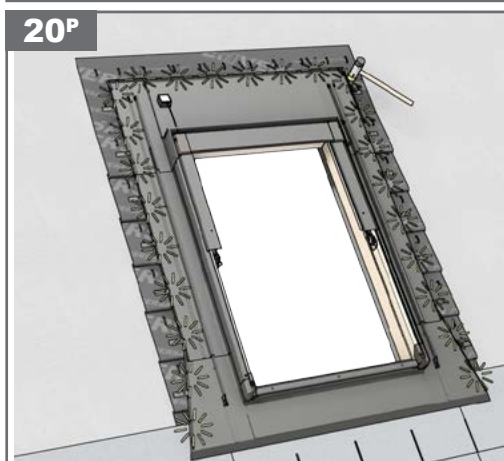
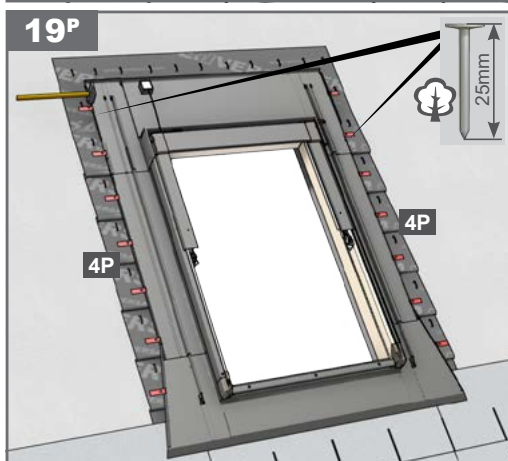
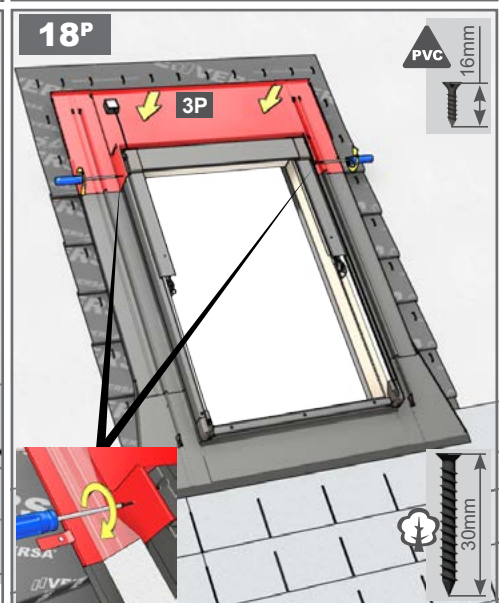
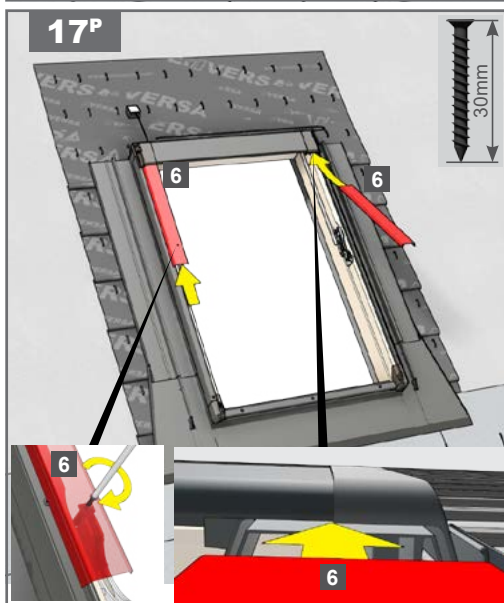
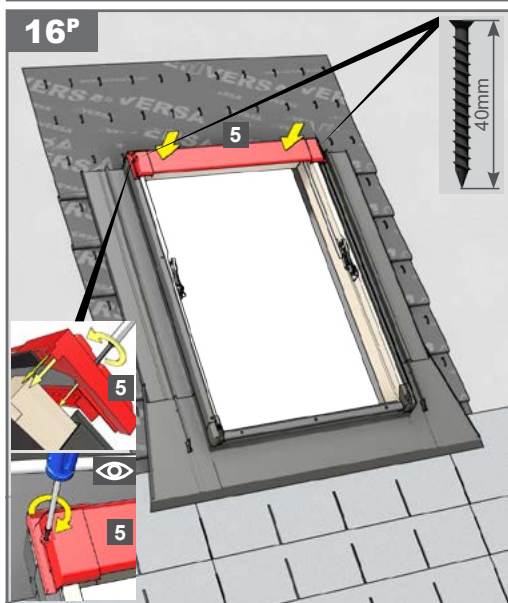
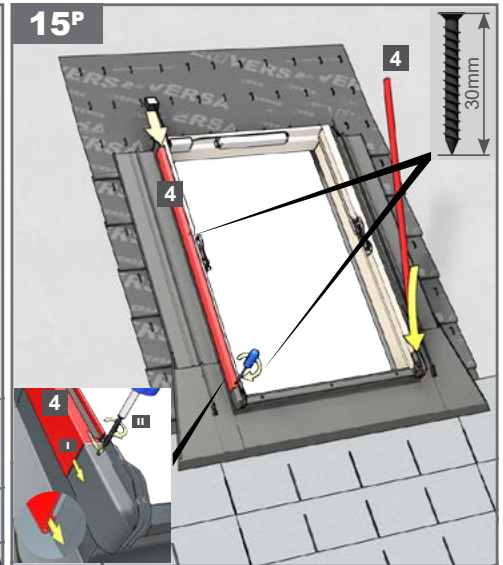
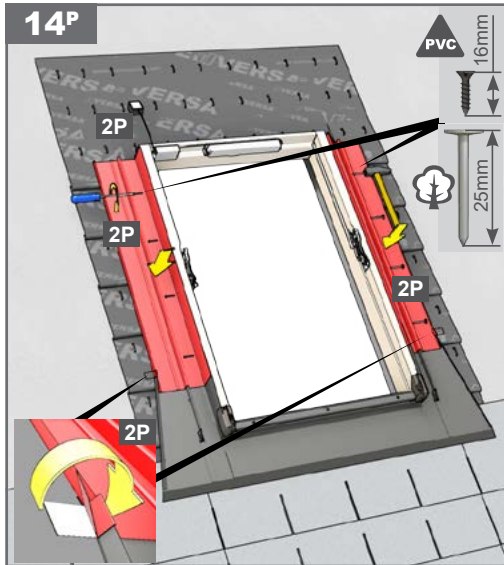
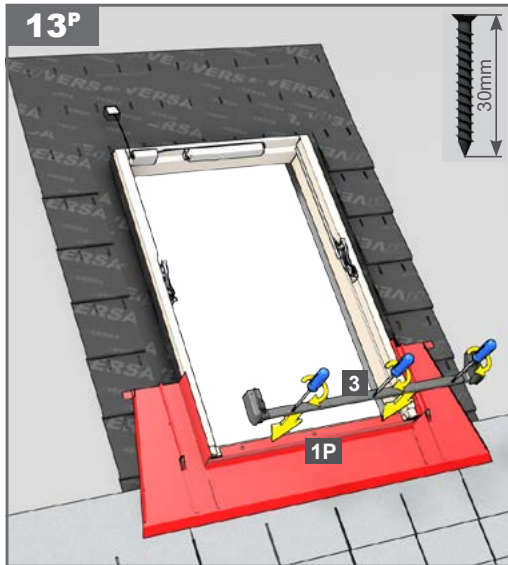
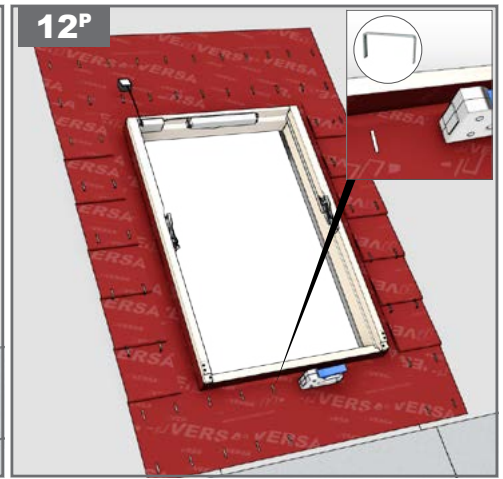
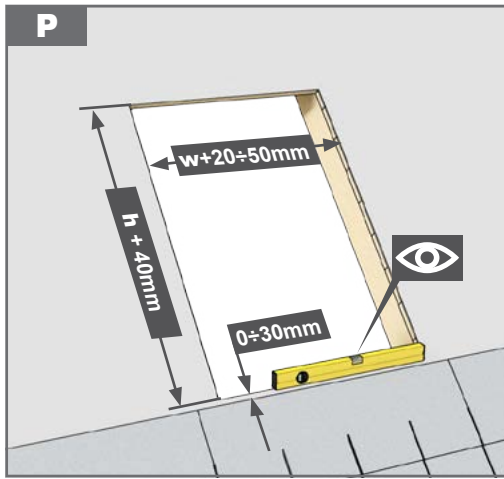
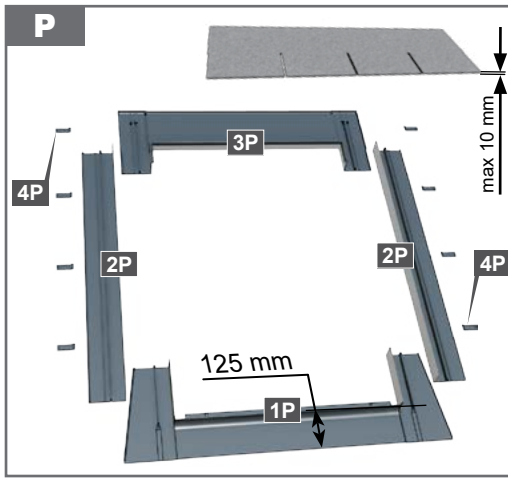

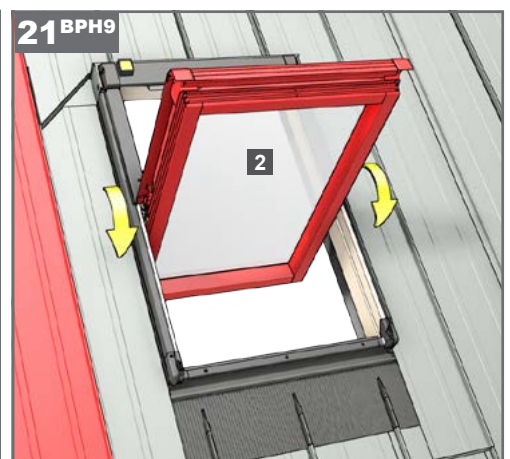
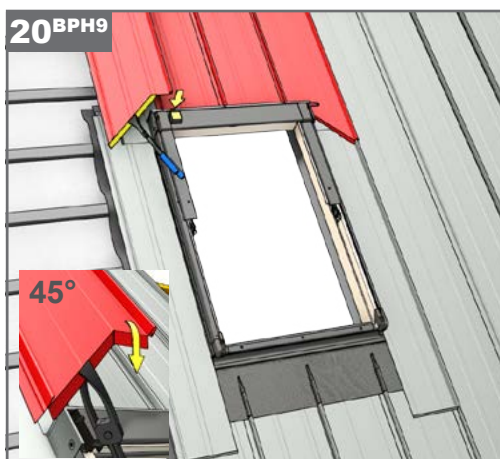
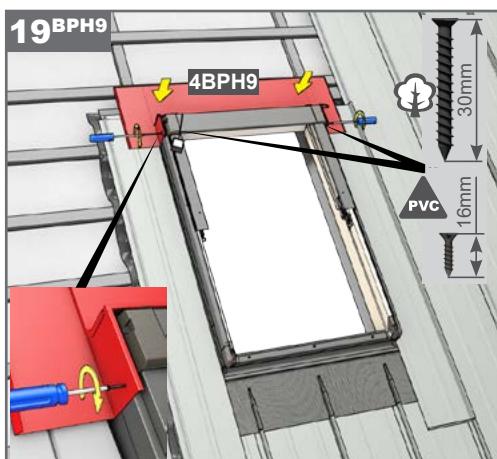
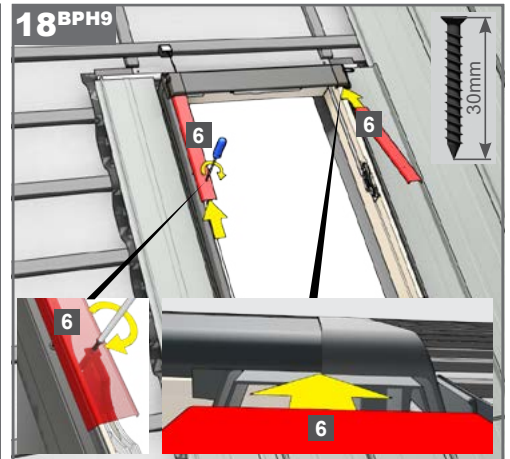
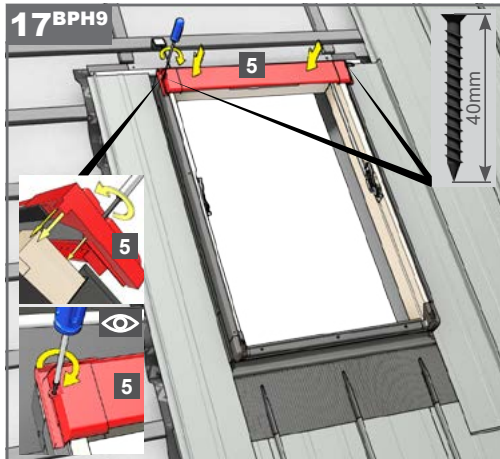
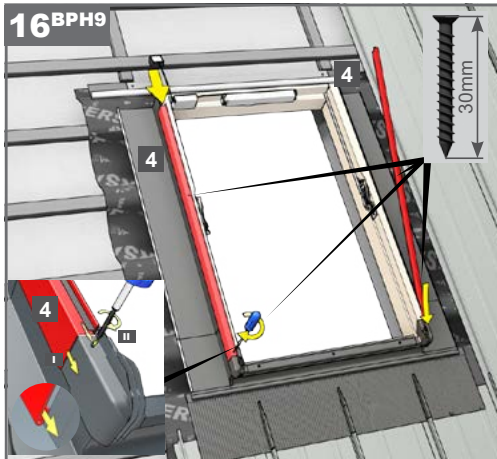
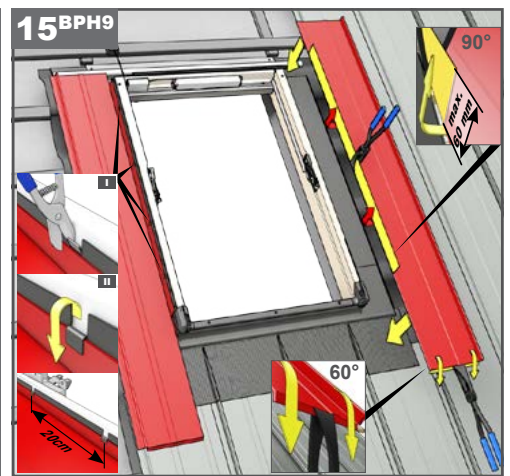
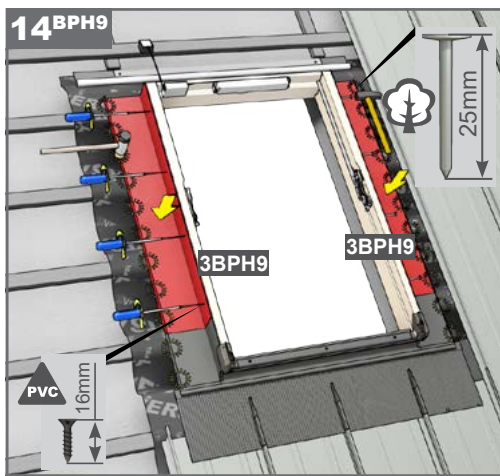
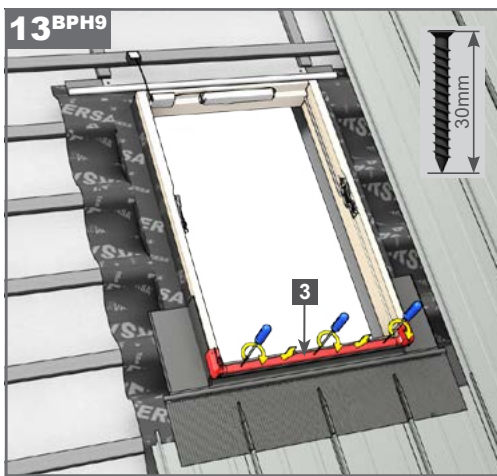
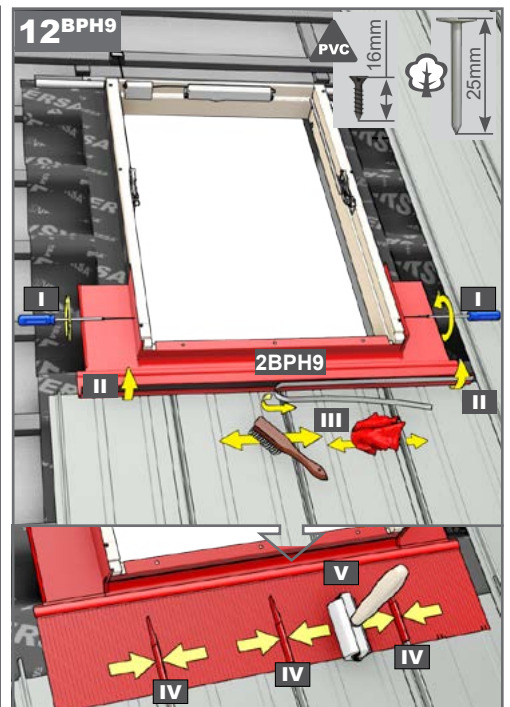
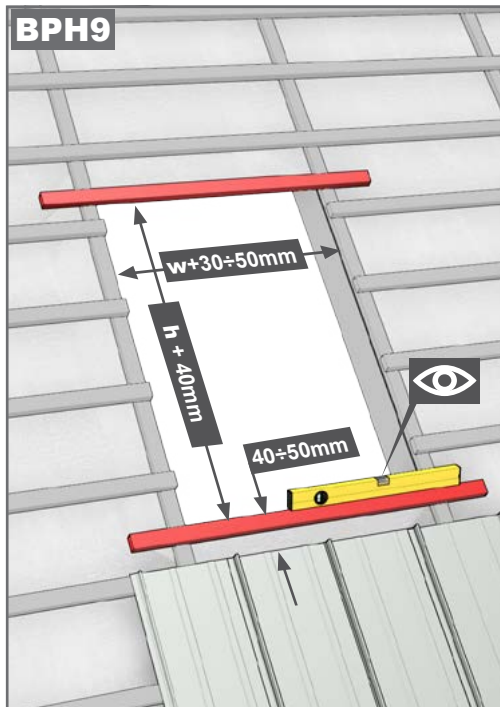
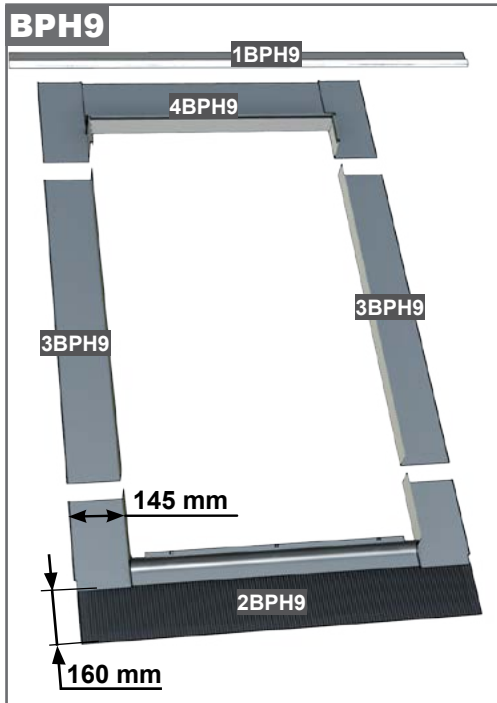

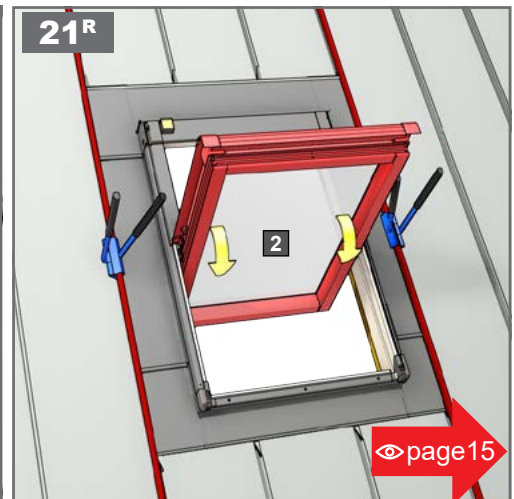
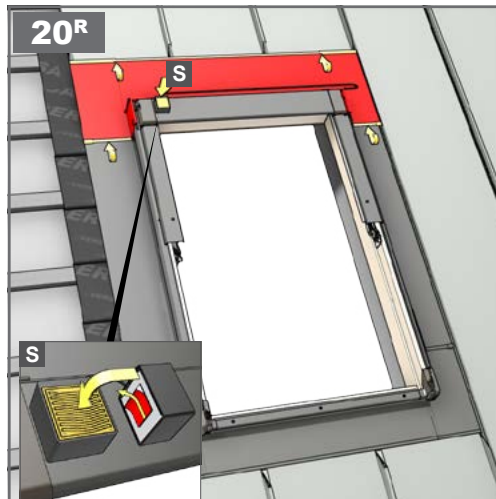
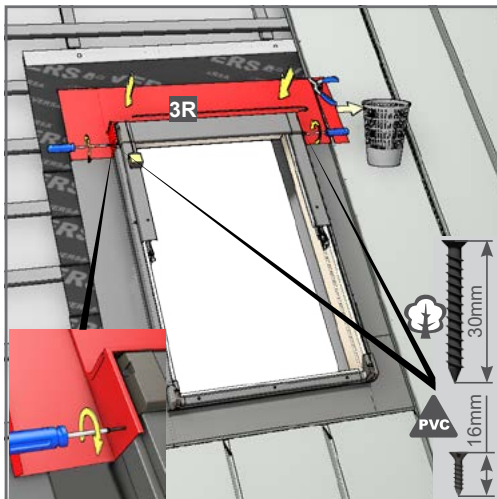
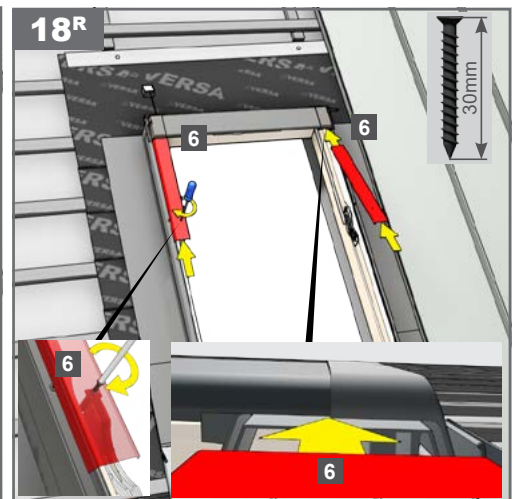
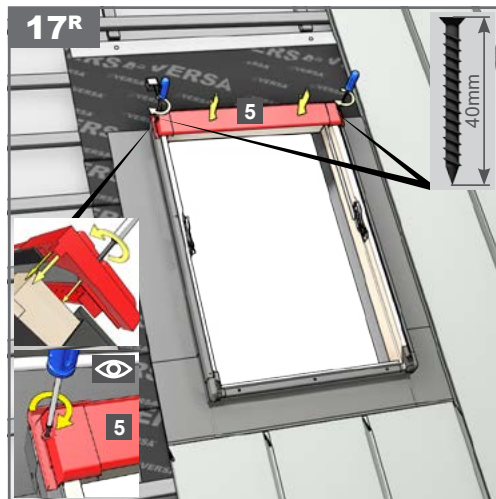
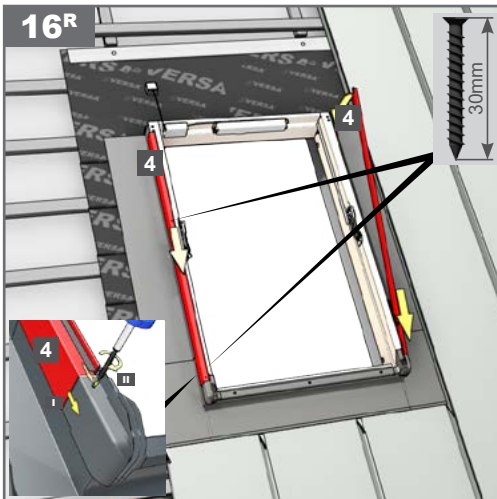
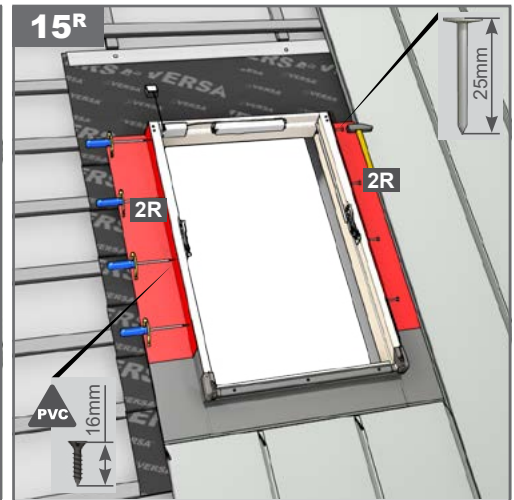
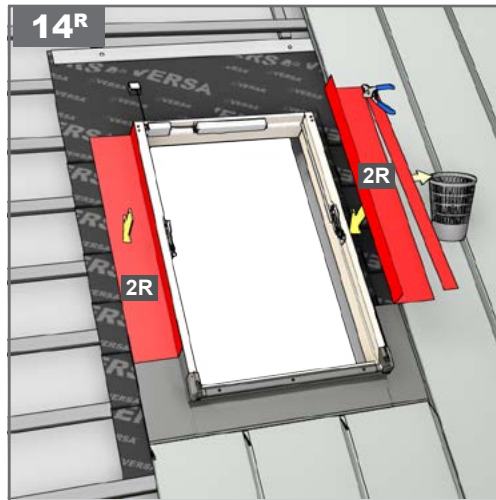
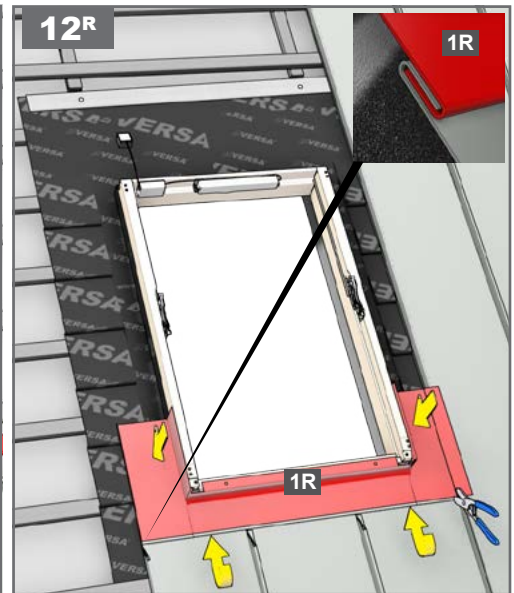
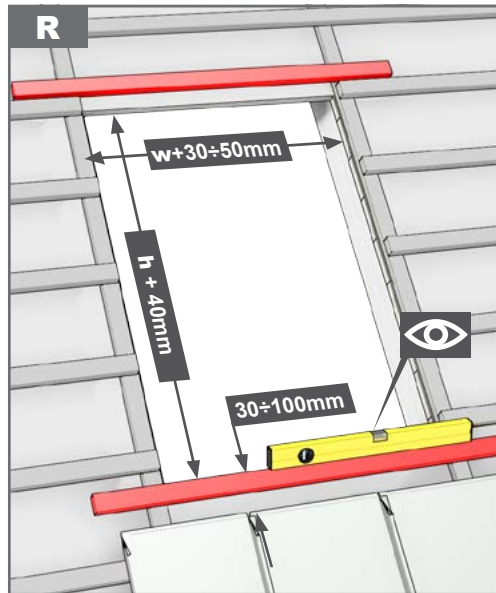
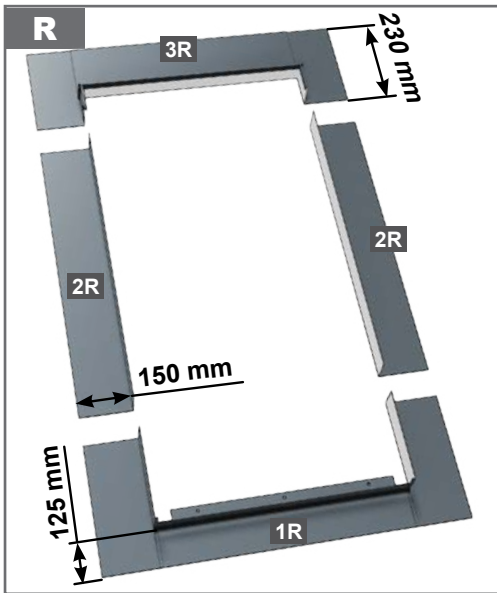



Uwaga! Proszę przeprowadzić niezbędną konfigurację użytkownika wg instrukcji.
Jeśli procedura nie zostanie przeprowadzona - ze względów bezpieczeństwa - należy odłączyć okno od źródła zasilania!

Attention! Please carry out the necessary user configuration according to the instructions. If the procedure is not carried out - for safety reasons - disconnect the window from the power supply!

Achtung! Bitte führen Sie die notwendige Benutzerkonfiguration gemäß der Anleitung durch. Wird der Vorgang nicht durchgeführt, ist das Fenster aus Sicherheitsgründen von der Stromversorgung zu trennen!

Atención! Realice la configuración de usuario necesaria según las instrucciones. ¡Si el procedimiento no se lleva a cabo - por razones de seguridad - desconecte la ventana de la fuente de alimentación!

Atenção! Efetuar a configuração necessária do utilizador de acordo com as instruções. Se o procedimento não for efectuado - por razões de segurança - desligue a janela da alimentação eléctrica!

Opgelet! Voer de noodzakelijke gebruikersorganisaties uit volgens de instructies. Als de procedure niet wordt uitgevoerd - om veiligheidsredenen - moet het venster worden losgekoppeld van de voeding!

Attenzione! Eseguire la configurazione utente necessaria secondo le istruzioni. Se la procedura non viene eseguita - per motivi di sicurezza - scollegare la finestra dall'alimentazione!

Attention! Veuillez procéder à la configuration nécessaire de l'utilisateur conformément aux instructions. Si la procédure n'est pas exécutée - pour des raisons de sécurité - débranchez la fenêtre de l'alimentation électrique !

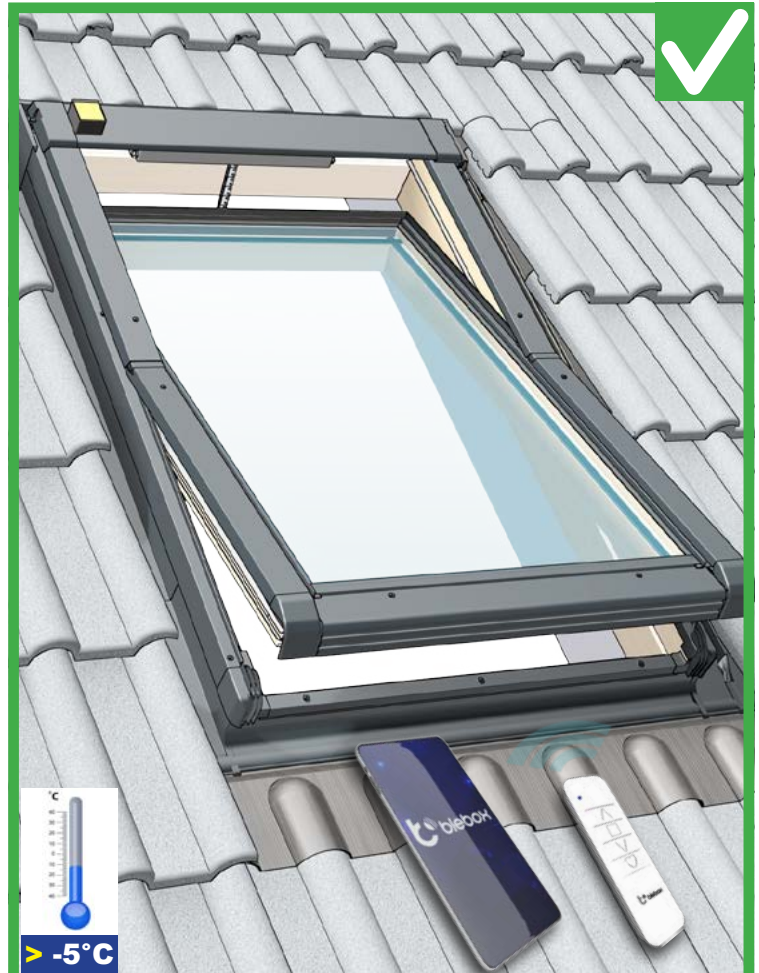



ISC IQ, VSC IQ

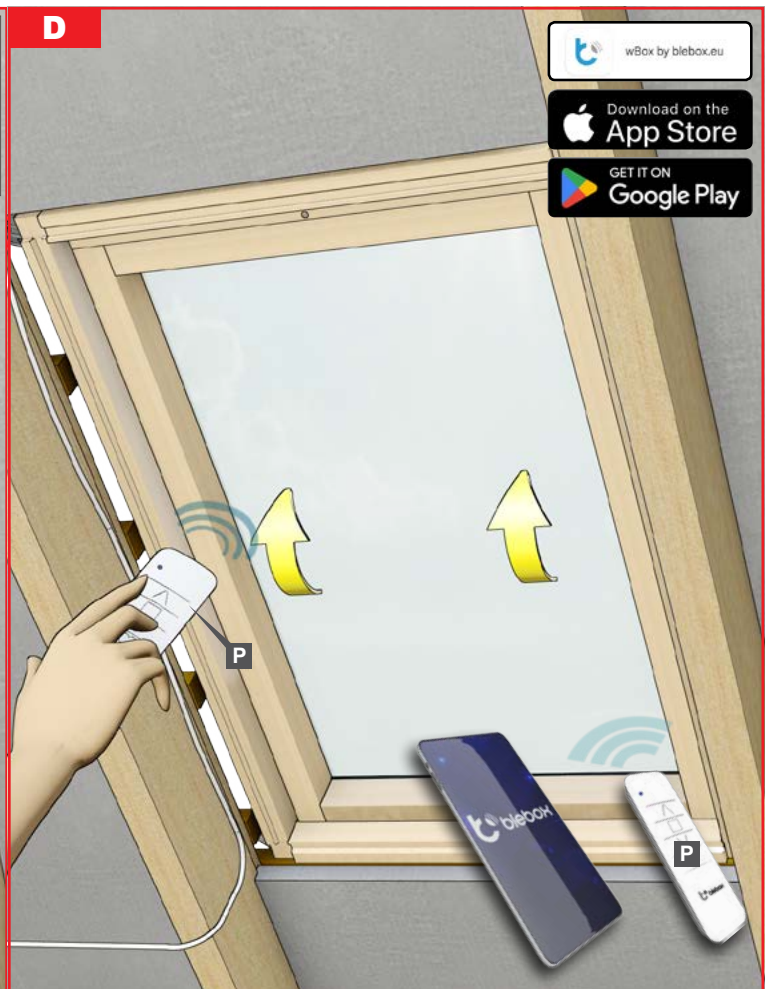
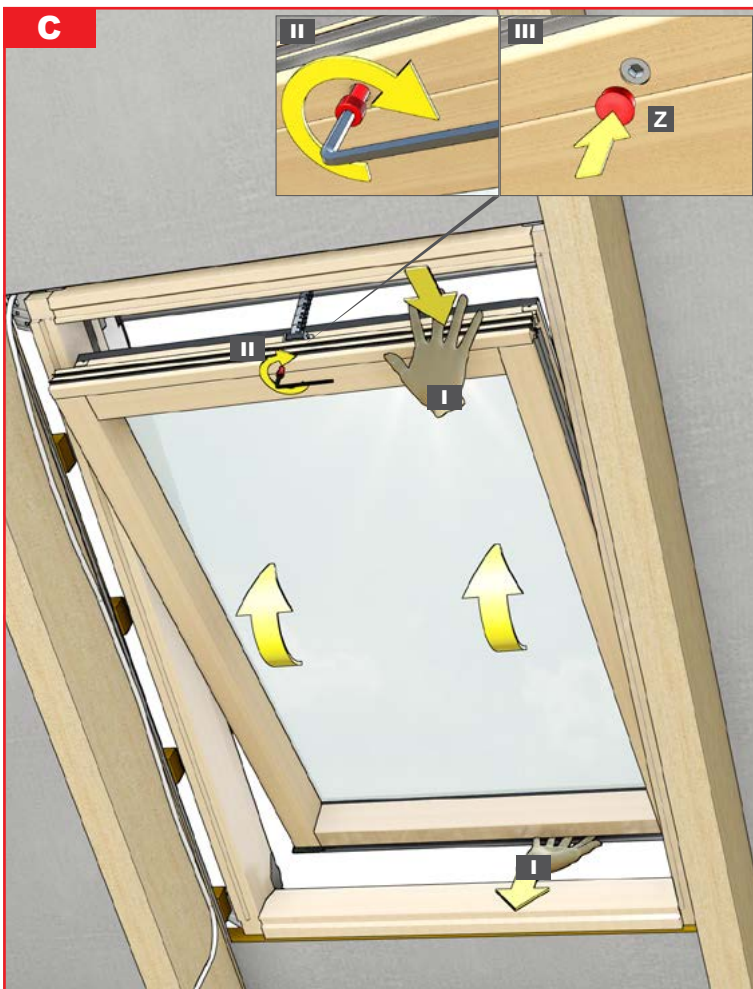
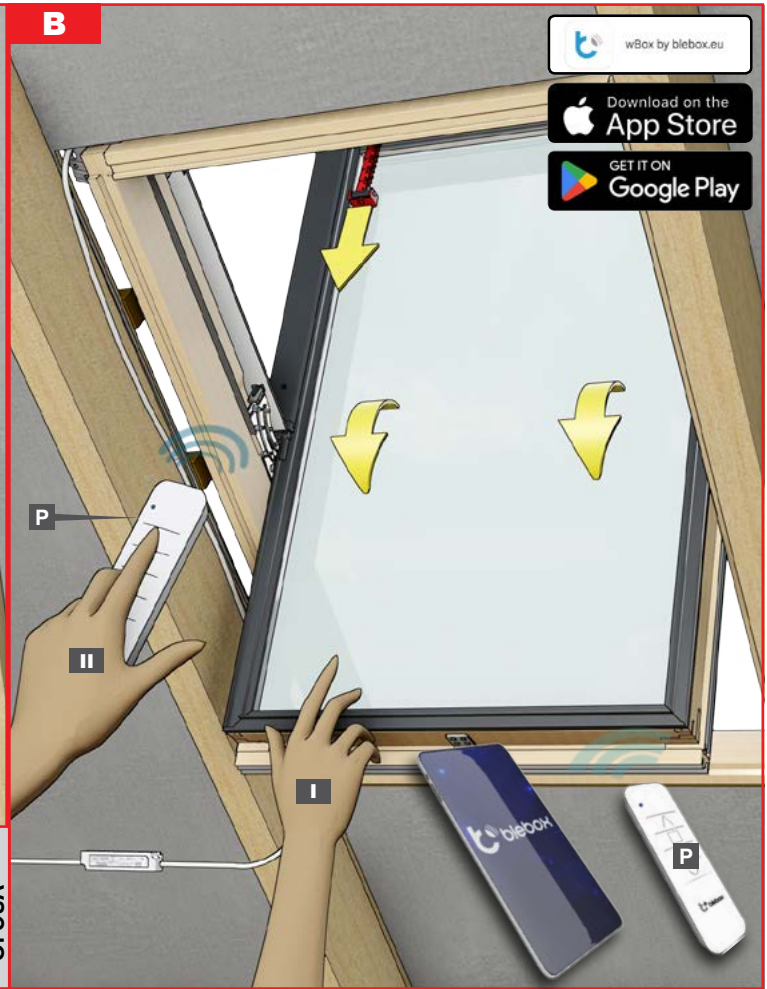



IGCV IQ



wBox by blebox.eu

Download on the App Store

GET IT ON Google Play

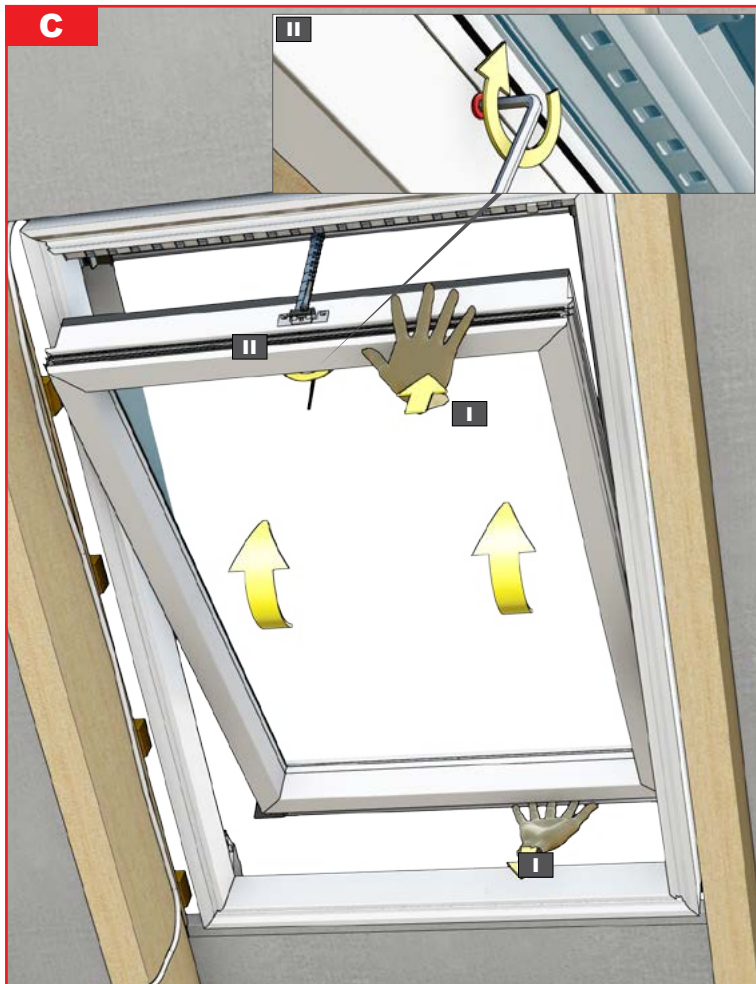

wBox by blebox.eu

Download on the App Store

GET IT ON Google Play

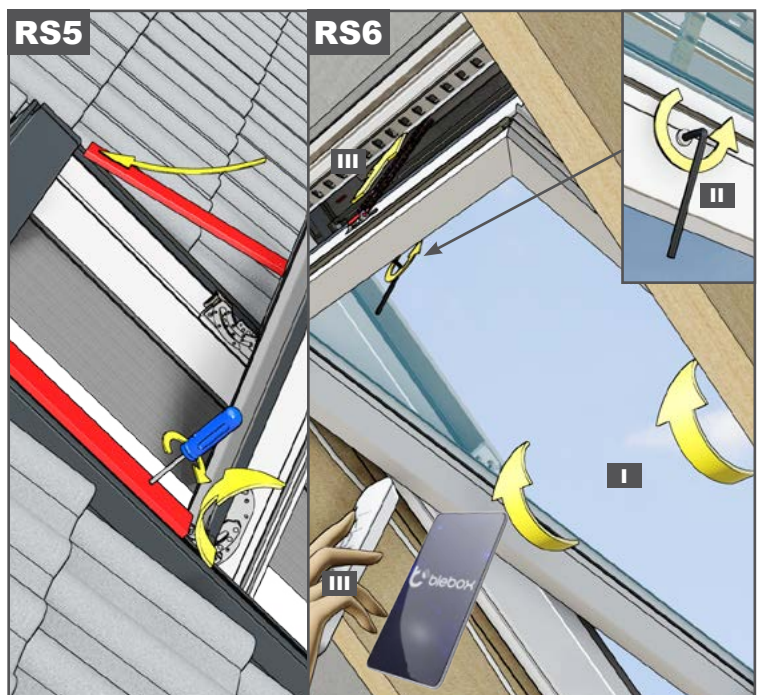
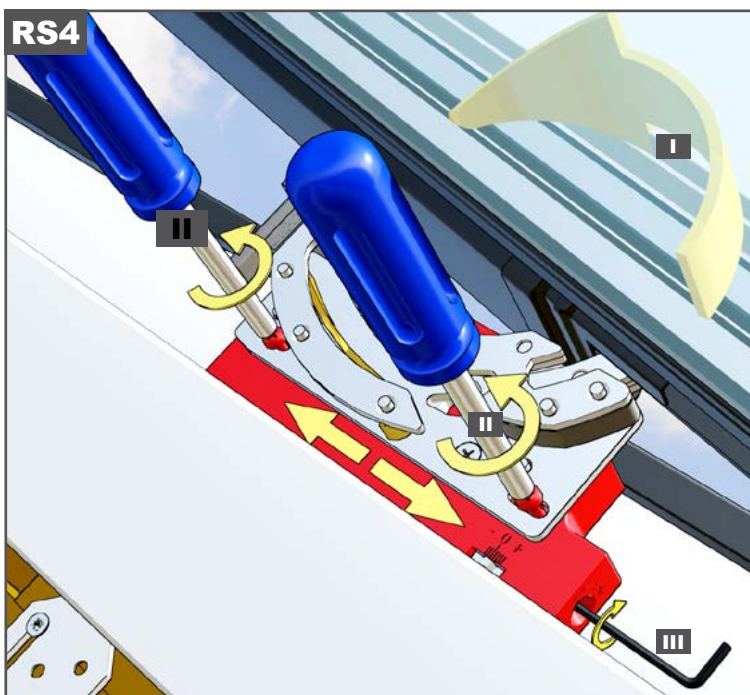
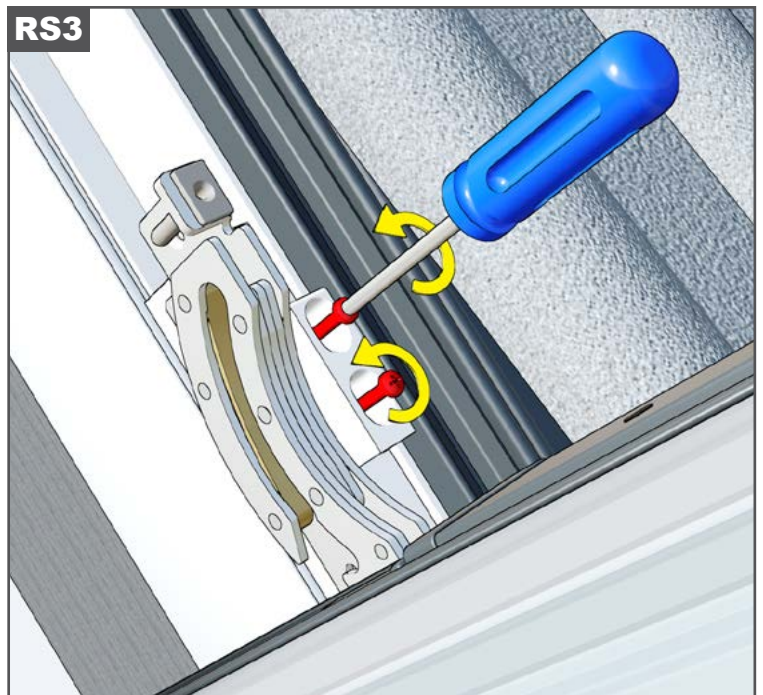
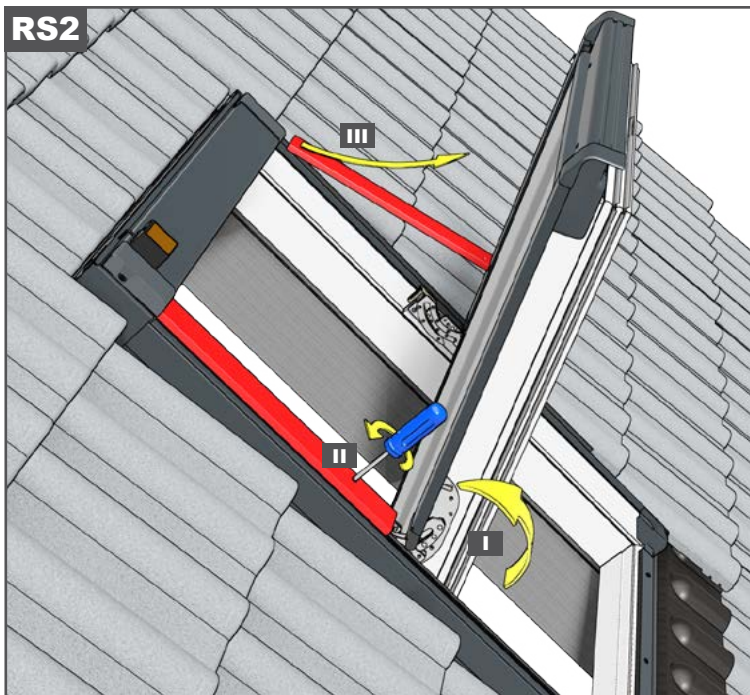
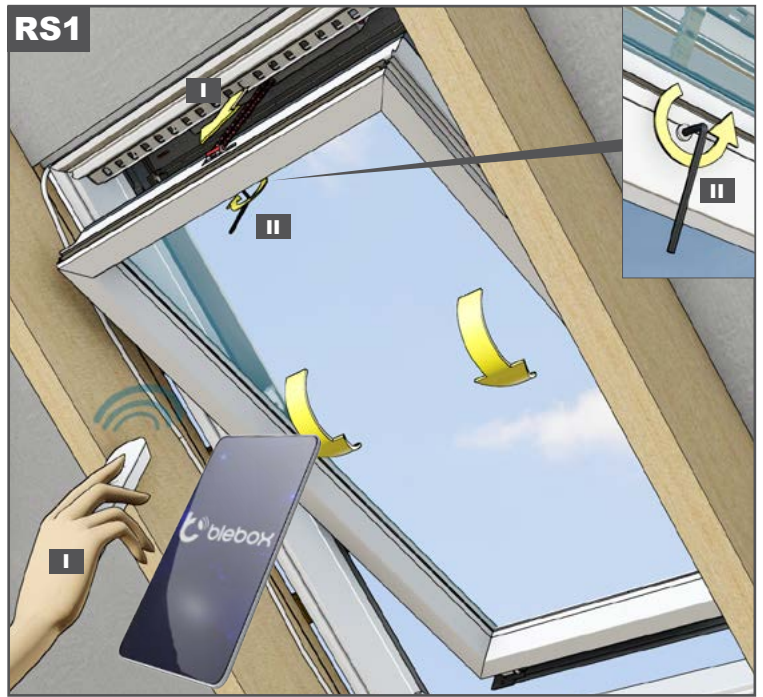
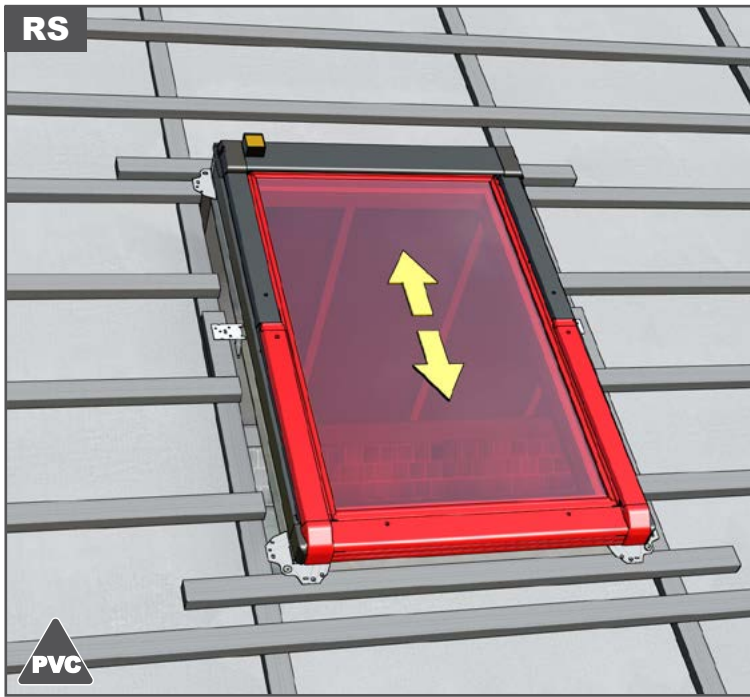

1 × YEAR

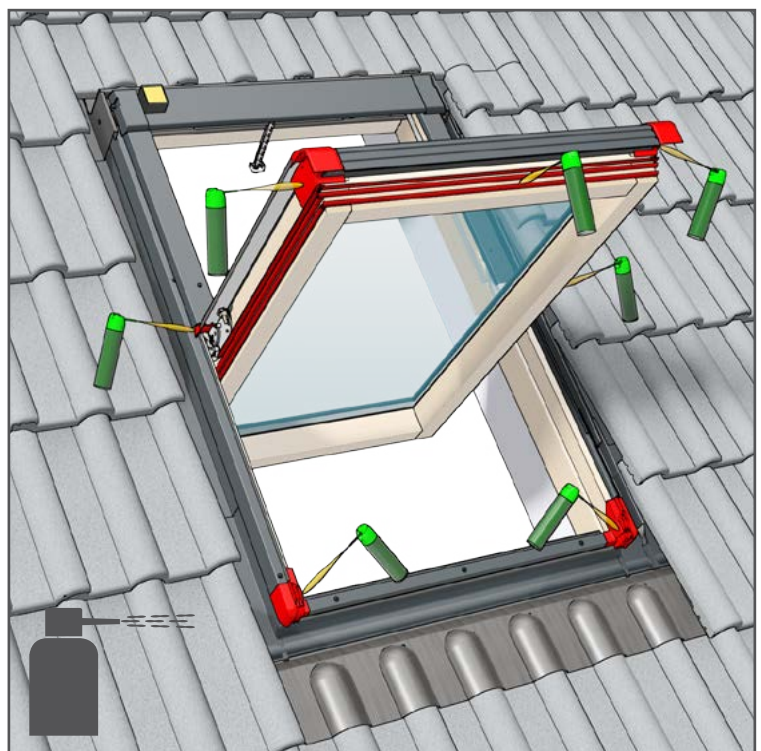
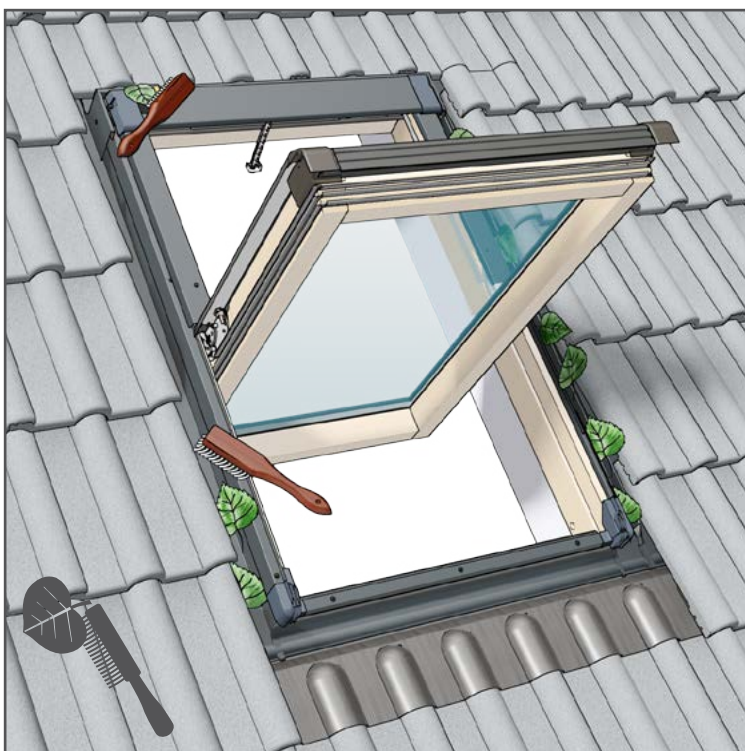
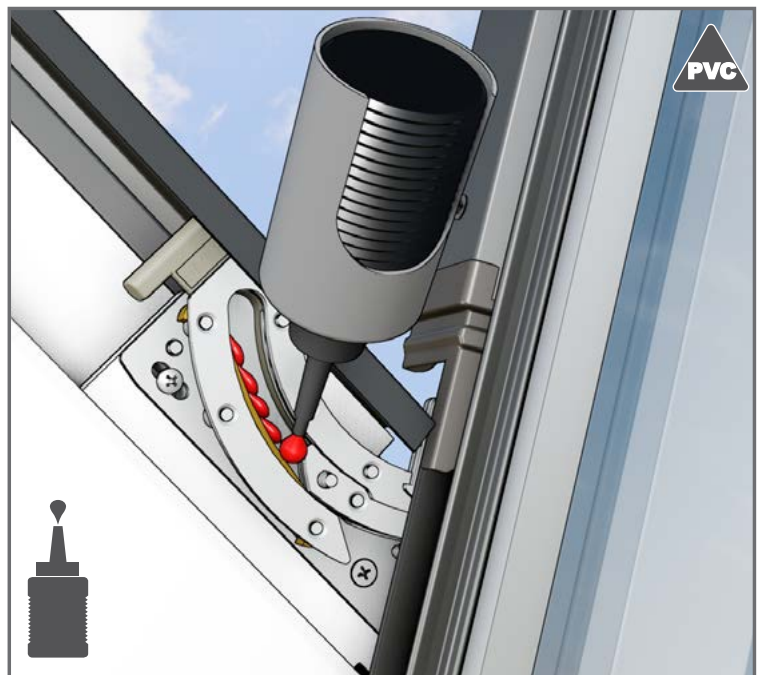

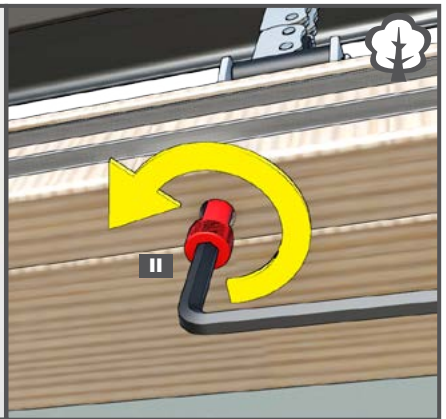
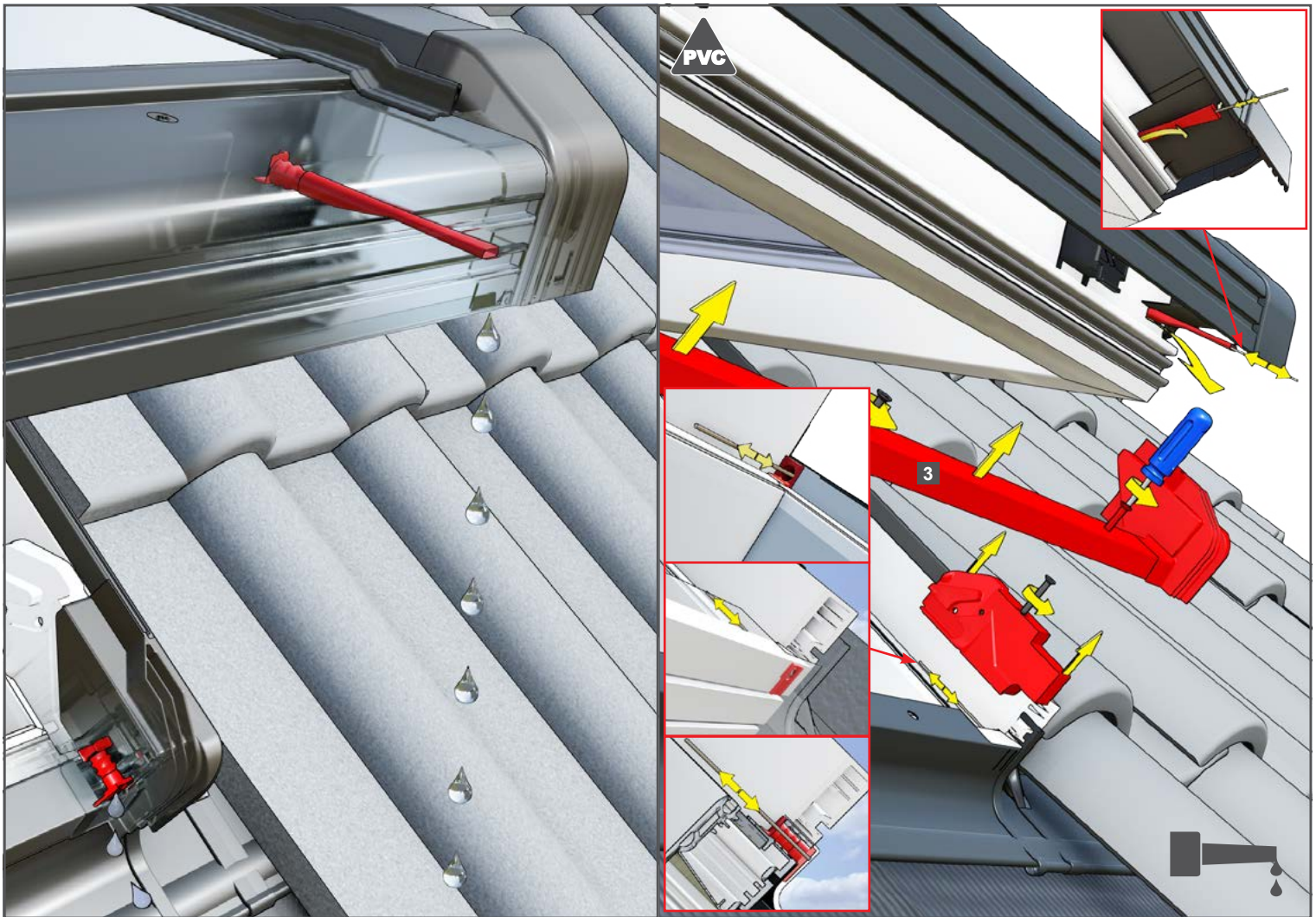

OKPOL®

OKPOL Sp. z o.o.

ul. Topolowa 24
49-318 Skarbimierz-Osiedle

e-mail: okpol@okpol.pl
e-mail: serwis@okpol.pl

Producent zastrzega, iż nie będzie ponosić żadnej odpowiedzialności za nieprzestrzeganie wymogów bezpieczeństwa oraz przepisów prawa jak również prawa budowlanego przez właściciela, użytkownika, montażystę oraz architekta.

The manufacturer reserves that it will not incur any liability for failure to comply with safety requirements and laws as well as construction law by the owner, operator, fitter and architect.